

Insulation System for Façades

www.foamglas.ae

FOAMGLAS®
Building



FOAMGLAS®

Contents

Aesthetics and protection	4
Principal types of façade	7
Ventilated rainscreen cladding	8
Folded metal cladding	14
Cavity wall insulation	16
Special façade cladding	20
Building physics	24
Fire protection	30
Economy	33
Excellent ecological profile	35



Aesthetics and protection

The façade of any building is far more than its aesthetic “face” – it fulfils various functions, all of equal importance to the structure as a whole. Primarily it needs to protect the fabric of the building from the effects of weather – cold, heat and rain. It also plays a key part in sound proofing the building and providing fire protection. Thermal protection is, of course, the most essential performance. FOAMGLAS® ensures that all the demands made on an insulation material are fulfilled with a performance that remains totally effective for the lifetime of the building.

- 1 Cavity wall insulation, Texas A&M University Doha-Qatar.
- 2 Cavity wall insulation, cantonal school “Luegeten”, Zug (Switzerland).
- 3 Ventilated rainscreen cladding, Intercontinental & Crown Plaza Hotel, Festival City, Dubai.



FOAMGLAS®
the ultimate insulation

FOAMGLAS® cellular glass insulation is unrivalled in performance whatever the building system. Cellular glass is foamed glass and constitutes of millions of closed, gas filled glass cells, which provide superior insulation characteristics. Due to the all glass cell geometry, the "vapour-control layer" is already built-in.

FOAMGLAS® is water- and vapour-proof, which means it is totally impervious to any form of moisture. Its high compressive strength makes the insulation resistant to compression – even under permanent loading. Other outstanding physical qualities of the glass material are: non-combustibility, dimensional stability (it cannot shrink or swell), it is rot-, insect-, vermin- and acid-proof (it will not support the growth of mould). FOAMGLAS® is environmentally sound (from manufacture to disposal) and is suited for all types of façade. The thermal insulation value remains as installed, for the lifetime of the building. The importance of the insulation and its performance cannot be overstated and is the key to an effective and financially efficient façade system.

FOAMGLAS®
the ideal façade solution

Materials, structures, colours and shapes: Every type of imaginative façade can be combined with FOAMGLAS® insulation. The FOAMGLAS® solution enables architect's schemes to be realised and adds to the structural stability of the whole cladding concept.

Independent of the wall- or cladding-system: Cellular glass insulation ensures exacting insulation values and the avoidance of cold bridging with a particularly thin façade structure. Nearly all façade materials are suited.

- **Warm façades: natural stone, clinker brick, metal, glass**
- **Ventilated façades (curtain wall): stone, timber, metal, glass, acrylic glass, fibre cement, wire mesh, trellis for greenery**
- **Cavity wall insulation: brick, lime-sand brick, exposed concrete**

FOAMGLAS®
clear advantages

For all demands: Whatever the weathering and temperature conditions a building may be exposed to, FOAMGLAS® protects the building structure and optimises the energy needs for heating or air-conditioning.

Cost-efficiency: FOAMGLAS®-insulation systems convince the client for their durability. In many a façade rehabilitation the existent FOAMGLAS® insulation was found unchanged after 40 years of use and could be left in place.

Safety: FOAMGLAS® proves to be the "safety insulation". This also means "fire safety". Cellular glass insulation is classified as non-combustible to Euro Class A1 – no contribution to fire.

Ecology: FOAMGLAS® is ecologically sound and has no environmental health hazards. Due to its outstanding service life and overall environmental sustainability, FOAMGLAS® cellular glass is best-rated in comparative analysis of environmental product declaration.

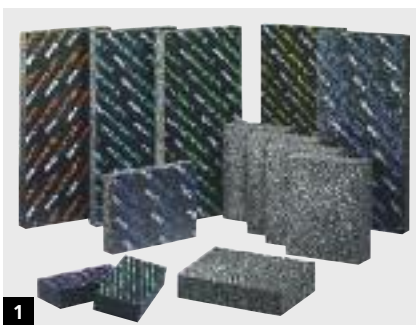

- 1 FOAMGLAS® Boards and slabs.
- 2 For every type of imaginative façade, Art Museum 'Kunsthaus Graz' (Austria).
- 3 Durability is the key to cost-efficiency, office building in Zurich (Switzerland).
- 4 Protection against heat and cold, Glacier 3000 cable car station (Switzerland).
- 5 National Convention Center Car Park, Doha, Qatar.



FOAMGLAS® Performance Properties for Façades

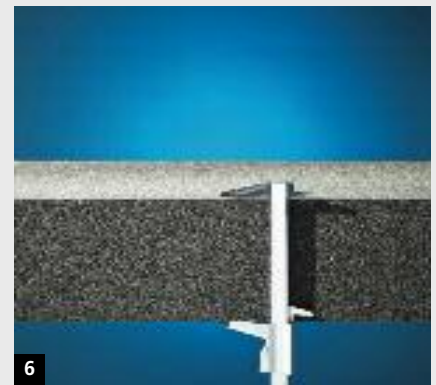
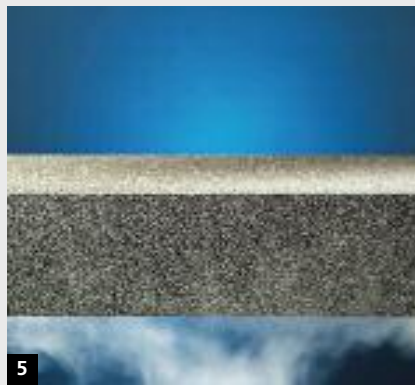
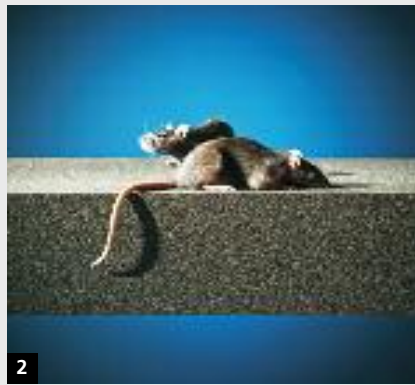

- 1 **Waterproof** FOAMGLAS® insulation is waterproof because it consists of pure glass. **Advantage:** It will never absorb moisture, so it remains dimensionally stable and maintains R-value for life.
- 2 **Pest resistant** FOAMGLAS® insulation is pest-proof because it is inorganic. It is also resistant to mold and mildew. **Advantage:** It can be used below grade without fear of infestation or absorption.
- 3 **High compressive strength** FOAMGLAS® insulation has an extraordinarily high compressive strength without deformation under load due to its unique cell geometry. **Advantage:** It can be used as a load-bearing thermal insulation without risk on roofs, decks, and plazas, and for below foundations.
- 4 **Non-combustible** FOAMGLAS® insulation will not burn because it consists of pure glass (ASTM E 136). It does not contain any blowing agents or flame retardants. Fire behavior: Classification according to ASTM E 84, smoke development and flame spread – zero. **Advantage:** Storage and processing not hazardous. No propagation of flames in the event of fire (chimney effect) in ventilation space.
- 5 **Vapour-tight** FOAMGLAS® insulation is air- and vapour-tight because it consists of 100% closed glass cells. **Advantage:** It is also a vapour barrier, so you can eliminate a layer of the assembly. R-value remains constant over time. There is no chance off-gassing or thermal aging. It can be used as a radon barrier below grade.
- 6 **Dimensionally stable** FOAMGLAS® insulation has a thermal coefficient of expansion similar to that of concrete and steel, meaning there is very little movement differential. **Advantage:** It will not swell, shrink, expand or contract. Using FOAMGLAS® can improve longevity of the roof membrane.
- 7 **Acid and chemical resistant** FOAMGLAS® insulation is resistant to organic solvents and acids because it consists of pure glass. **Advantage:** No destruction of the insulation by aggressive mediums and atmospheres.
- 8 **Easy to cut** FOAMGLAS® insulation is easy to work with because it consists of thin-walled glass cells. **Advantage:** It can be cut to any desired measurement using a simple handsaw.
- 9 **Ecological** FOAMGLAS® insulation is free of environmentally damaging flame retardants and blowing agents and offers a low embodied energy compared with polymer-based insulation materials. **Advantage:** After generations of use it can be recycled as filler in landscaping or thermally insulating granulate. FOAMGLAS® can help meet your LEED and Living Building challenges.

Principal types of façade with FOAMGLAS® thermal insulation



Ventilated rainscreen cladding

Combined with various types of cladding in metal, stone, glass, wood, waterproof composite panels, vines, etc. ..., the air- and waterproof FOAMGLAS® insulation blocks (sealed joints) are suited to be integrated in ventilated façades without additional rainscreen. The system has been designed for fasteners that minimize thermal bridges and has proven high reliability.

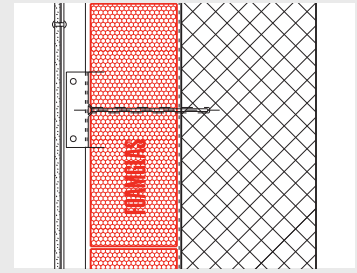

External thermal insulation kit system

Rigidity and dimensional stability of FOAMGLAS® insulation provide the ideal conditions for render systems. The insulation does not absorb any moisture and thus contributes to the longevity of the render. With its compressive strength, structural fixing of rigid underlays is possible on top of the insulation if bonded facings (bricks, ceramics, glass ...) are the finish option.

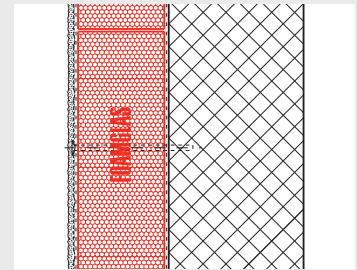

Folded metal cladding (no vent gap)

Compressive strength and moisture barrier provided by FOAMGLAS® allow the mechanical fixing of folded metal sheets without ventilation gap, due to the unique FOAMGLAS® fixing plate concept. This system minimizes thermal bridges and allows to save space with a very slim cladding system.

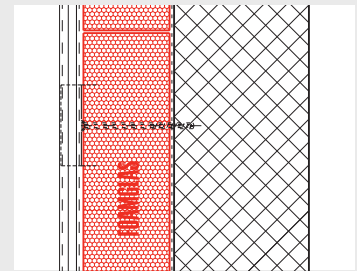

Cavity wall insulation

Structures with double masonry walls offer many advantages, however the cavity wall insulation is quite inaccessible. Therefore the use of rot-proof, fire-proof and damp-proof FOAMGLAS® insulation ensures a resilient system with best thermal performance of the walls in the long term, in summer and winter. Moreover cellular glass insulation is not absorbed or infested by pest.

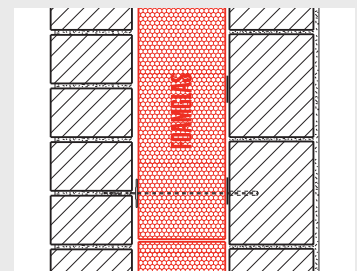

Special façade claddings

From open screen wire mesh claddings to solar panel cladding, façades are directly exposed to all sorts of stresses: external and internal moisture conditions, attack from rodents, insects and termites. They moreover have to cope with fire safety requirements. All-weather FOAMGLAS® - mounted in a simple and robust wall structure without rainscreen - offers efficient solutions.

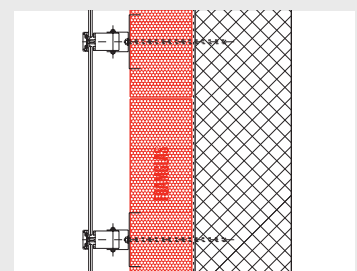



Ventilated façade

Intercontinental & Crown Plaza Hotel, Festival City, Dubai, UAE

Client Al-Futtaim Group

Architect Cox Crone Architects

Construction 2003–2007

Application of FOAMGLAS® behind stone cladding facade 8000 m²

The Intercontinental and Crown Plaza Hotel are part of Festival City project which will be once finished one of the largest mixed-used development in Dubai. FOAMGLAS® is used behind the stone cladding because of the unique property of fully resistant to any kind of water and vapour and therefore can be applied on the wall structure without any additional protection against the high humidity. No additional foil for vapour protection is required through the closed cell structure of the material FOAMGLAS® itself. Result is the life time constant performance of the thermal insulation. Degradation through humidity abortion is the biggest problem in the Middle East for wall insulation next to fire issues. FOAMGLAS® is fully inorganic and will not support any fire. With no flame spread and no smoke development it provides specially in hotel project with towers the highest safety and ensures even in the building envelope the highest standard.

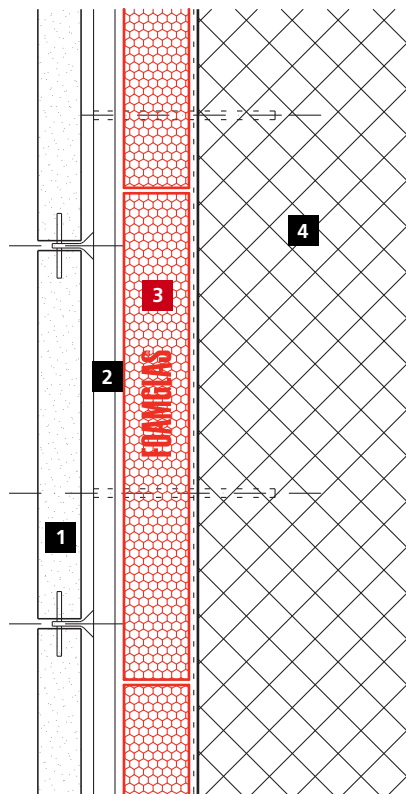

Long term investment in safety and durability

www.foamglas.ae

Build-up

- 1 Stone cladding
- 2 Rail support system for cladding fixed in concrete
- 3 FOAMGLAS® mechanically fixed
- 4 Structural wall concrete





Ventilated rainscreen cladding

Museum of Islamic Art, Doha-Qatar, UAE

Architect I.M. Pei

Construction 2007

FOAMGLAS® application behind stone cladding facade mechanically fixed.

Total area of FOAMGLAS® applied for facade and flat roof 22 000 m²

The Museum of Islamic Art is situated on the southern part of Doha's seafont on a manmade island about 60 meters off the coast of Doha. The external wall of the Museum is finished with 6,500 M3 of natural stone work. High temperature combined with high humidity and an open joint application of the facade was asking for a high quality of the structure below, specially the thermal protection because access to the ventilation space is not provided any more. The FOAMGLAS® cellular glass insulation with the closed cell structure guarantees a life term solution because it can never absorb any humidity neither from humid air nor from rain or condensation. The lifelong constant performance is ensured and any upgrading of HVC equipment never required.

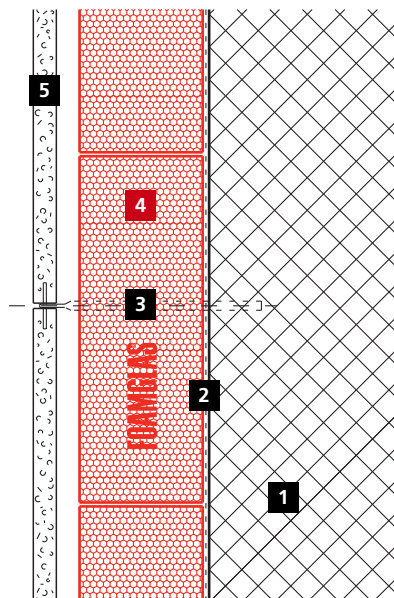

Stable value and out-standing service life using top-quality materials

www.foamglas.ae

Facade structure

- 1 Solid wall (concrete/brickwork)
- 2 Primer coat
- 3 Resin anchor
- 4 FOAMGLAS® slabs, bonded with PC® 56
- 5 Large format stone slab cladding





Ventilated rainscreen cladding

The IAACC Pablo Serrano Museum, Saragossa, Spain

Owner The Culture Department of Zaragoza

Architect José Manuel Pérez Latorre

Construction 2010

Constructor Nexometal

Thermal insulation 7000 m² FOAMGLAS® READY BLOCK 60 mm

Finish Composite Panel

Having extended and renovated its existing building, the IAACC (Instituto Aragonés de Arte y Cultura Contemporáneos) Pablo Serrano re-opens its doors and is set to become a benchmark for contemporary culture not just in the Aragon region but on a national and international level. The newly opened museum aims to provide deepening knowledge of the Aragonese sculptor from whom it gets its name. The Pablo Serrano Museum is located in the old workshops of the Provincial Orphanage, which were refurbished by the architect José Manuel Pérez Latorre, to suit the new role as museum. The interior includes the work of Pablo Serrano combined with temporary exhibitions of contemporary painting and sculpture. The space of the new building is amazing, with its volume increased from 2 500 m² to 7 500 m², it is furthermore enhanced by an unusual fenced area incorporating an external light enclosure which is painted in a special colour that looks like "a precious stone reflecting the sky". FOAMGLAS® has been chosen

because it could ensure dimensional stability and unaltered performance throughout the entire service life of the building.

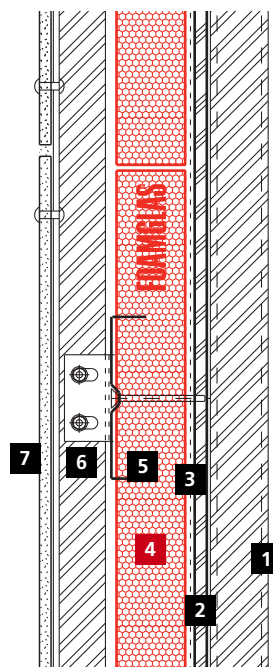

Safety and aesthetics – a new system becomes the thing
www.foamglas.ae

Build-up

- 1 Steel structure
- 2 Timber pannel
- 3 Primer
- 4 FOAMGLAS® READY BLOCKS (60 mm), glued in full adherence
- 5 Perforated metal plates PC® SP 150 x 150 mm (fixed through the trimber pannel)
- 6 L aluminum profiles (fixed inside the metal plates)
- 7 Composite panels





Ventilated rainscreen cladding

The Bachhaus Museum, Eisenach, Germany

Architect Penkhues Architekten, Kassel

Construction 2006

FOAMGLAS® application Behind stone cladding façade, mechanically fixed 620 m², Type W+F, thickness 100 mm, adhered

Cladding Natural stone cladding

The Bachhaus Eisenach is the first museum in the world dedicated to Johann Sebastian Bach. It contains not only archive materials, household effects and bibliographic treasures from the times of Bach, but also a valuable collection of musical instruments as well as a specialty library.

To ensure lifetime performance of the façade it is not only the outer skin that needs to be high-end, but also the support structures and the thermal insulation layer in order to meet the quality demands. The FOAMGLAS® system provides high functional performance and is unaffected by driving rain and water vapour. It meets all the requirements of this type of high quality façade system and will perform for the lifetime of the building.

When façade claddings are inclined inwards, they impose high demands on the thermal insulation applied to the structure. FOAMGLAS® gives full security, as it does not sag or warp and cannot create any blockage of the rear

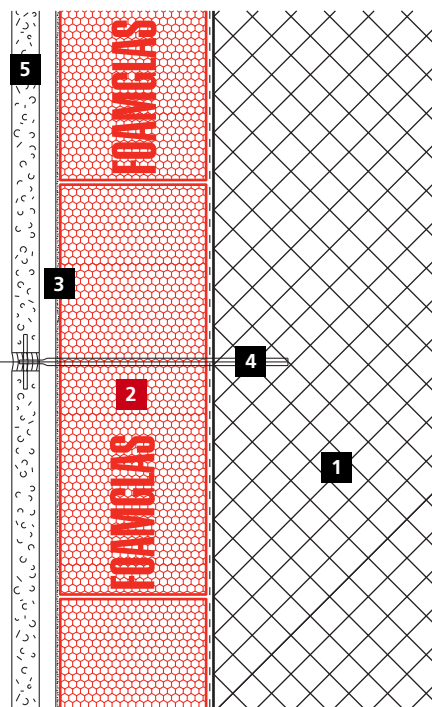

ventilation space. FOAMGLAS® provides heat and moisture protection in any position. The design possibilities are limitless.

Constant thermal value and outstanding service life using top-quality materials
www.foamglas.ae

Build-up

- 1 Substrate
- 2 FOAMGLAS® W+F, adhered with PC® 164
- 3 Coating Pittcote® 404 with reinforcing mesh PC® FABRIC 79P
- 4 Anchors
- 5 Natural stone cladding





Ventilated rainscreen cladding

Schwyzer Kantonalbank, Pfäffikon, Switzerland

Architect Halter Architekten AG, Rapperswil

Construction 2003

FOAMGLAS® application Façade insulation, about 600 m², T4+ slabs, 160 mm thick, adhesively bonded, and paint finish

Façade cladding ESG glass cladding, 10 mm thick, with silk-screen printing – discharge print imitation, metal substructure fixed to a structurally fixed supporting plate, glass cladding with visible fixing points

Glass façades impose extreme loads on the substructure and in particular on the thermal insulation behind it. Due to retained heat, extremely high temperatures are created and these can rapidly drop when rain occurs. As a consequence condensation can form in the façade structure. FOAMGLAS® insulation is impervious to water and water vapour and will not allow deterioration from condensation. It has dimensional stability and resistance to expansion or swelling even under severe temperature fluctuations and moisture conditions.

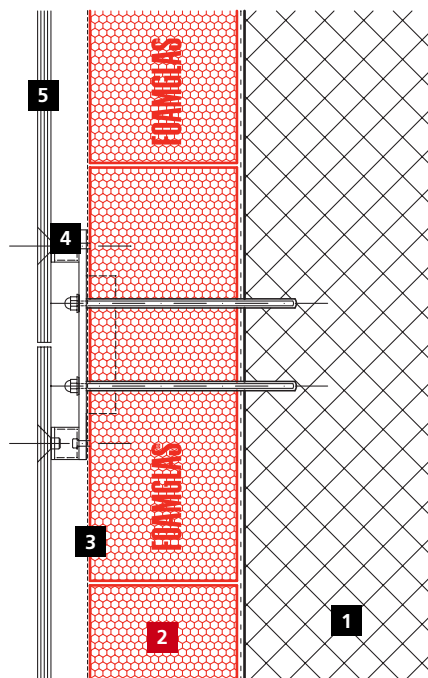

Dimensional stability and resistance to expansion or swelling under temperature fluctuations and moisture conditions
www.foamglas.ae

Façade structure

- 1 Concrete structure
- 2 FOAMGLAS® T4+ insulation, adhesively bonded
- 3 Paint finish
- 4 Supporting plate, mechanically fixed to the structure
- 5 Glass cladding





Rainscreen cladding, cassette system

Tour des Tilleuls, Wattrelos (59), France

Architect VDDT Architectes Associés (59)

Client Vilogia

Contractor Coexia (59)

Construction 2009 (refurbishment)

As real estate owner Vilogia has key requirements for sustainability and energy efficiency. A priority for his restoration works is long term reliability and best cost efficiency. Constant thermal performance, i.e. an insulation system without thermal ageing during construction and after completion, was a decisive criteria for choosing FOAMGLAS® thermal insulation. The system resists to all weather conditions and has excellent vapour proofing capacities.

The use of innovative, U-shaped Foamfix fixing brackets to hold the subconstruction for the pre-formed coated steel cladding sheets was a contribution to improved and rational operations on the building site.

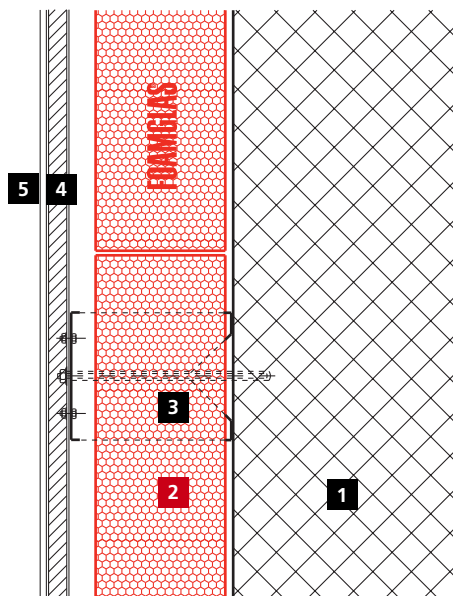

FOAMGLAS® – thermal insulation for long term reliability
www.foamglas.ae

- 1 Structural wall
- 2 FOAMGLAS® W+F (100 mm thickness) bonded with PC®56 adhesive
- 3 U-shaped fixing bracket and spacer Foamfix
- 4 Subconstruction
- 5 Cassette cladding system, pre-formed interlocking steel panels





Metal façade and roof

Photos © Tim Crocker

The Granary, Abbey Road, Barking, U.K.

Client Roof Ltd; **Local Area Master Plan** Schmidt Hammer Lassen Architects

Architects Pollard Thomas Edwards Architects

Structural Engineers Price & Myers; **Contractor** Roles Broderick Roofing Ltd

Construction 2010-2012

FOAMGLAS® application Façade, FOAMGLAS® W+F, 150 mm thick, adhesive fixed; Roof, FOAMGLAS® READY BOARD T4+, 200 mm thick, adhesive fixed

Cladding KME, Tecu Bronze to BS EN 1172

The grade II-listed 120-year-old Granary building and the Malthouse are among the oldest buildings within the East London district of Barking and Dagenham. In 2009 the redevelopment master plan was prepared by Schmidt Hammer Lassen Architects. Design for the Granary and Malthouse was carried out by Pollard Thomas Edwards Architects, which certainly achieved the client's key requirements for sustainability and energy efficiency. Steve Drury, Roof development director, commented "At an early stage FOAMGLAS® insulation was specified for its environmental qualities and long-term reliability. It is impervious to water and water vapour, it actually provided an element of exterior weather-proofing as the building works progressed." Interior works could commence while the metal façade was still being installed. FOAMGLAS® insulation, with its unique cladding fixing system, kept thermal bridging to a minimum; the resulting U-value performance exceeds Building regulations by more than 25%. With time the KME Tecu Bronze exterior

will take on a natural patina. The metal exterior has a potential lifetime of well over 200 years, so it's crucial to use an insulation with a proven long-term performance. With FOAMGLAS® thermal aging does not take place. It is the ideal insulation to combine with roof and façade materials such as KME Tecu Bronze. For the pitched roof FOAMGLAS® READY BOARD T4+ was bonded and sealed to the timber board structure with PC® 11 adhesive. Metal plates type PC® SP 150/150 were inserted into the FOAMGLAS® READY BOARD. A 180 g/m² sanded bitumen membrane was torch-applied onto the surface.

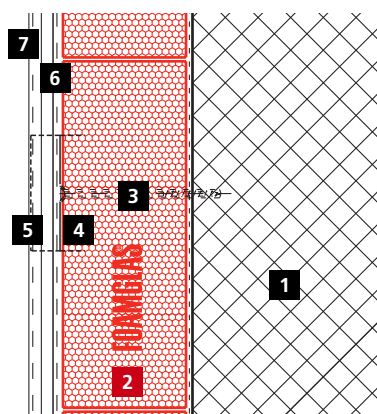

World Architecture News, Winner 2011.
New London Awards, Winner 2012.
Civic Trust Awards, Winner 2012.
www.foamglas.ae

Build-up

- 1 Timber (wall structure)
- 2 FOAMGLAS® W+F slab, bonded with PC® 11 adhesive
- 3 Thermally isolated screw fixing
- 4 Metal plates PC® SP 150/150
- 5 Fixing clips
- 6 Separation underlay
- 7 KME - Tecu Bronze: 0.7 mm thick; pre-formed interlocking large format shingles; spec DIN EN CuSn4, secured with stainless steel clips and screws to the PC® SP 150/150 metal plates





Tecu gold standing seam, façade and roof

Photo © KME,
Tecu Consulting UK

Firstsite Visual Arts Centre, Colchester, Great Britain

Client Colchester Borough Council, Colchester

Architects Raphael Viñoly Architects; **Structural Engineer** Adams Kara Taylor

Cladding Contractor Richardson Roofing; **Contractor** Banner Holdings

Construction 2008

FOAMGLAS® application Façade, FOAMGLAS® W+F slab, 100mm thick
Roof, FOAMGLAS® READY BOARD, 200mm thick

Cladding Tecu gold standing seam (a copper aluminum alloy) by KME

World renowned Architect Rafael Viñoly and manufacturer Pittsburgh Corning have given Colchester's Visual Arts Centre a resilient FOAMGLAS® cellular glass insulation solution with a wonderful golden glow. Colchester, known as Camulodunum, is one of the country's earliest Roman settlements and has a ground loaded with archaeology. English Heritage has insisted on a "no dig" policy, so the arts centre is built on its own artificial plinth of spoil and a ground-bearing concrete slab. The idea is that the building can rest on the earth without disturbing any hidden artifacts beneath. The envelope of the building is a quite intricate layered system.

FOAMGLAS® cellular glass insulation is used for the roof and the façade. The façade had a FOAMGLAS® W+F slab of 100 mm applied; this was adhered using PC® 56 to the plywood substrate, with the Tecu gold sheets seamed and fixed into position. Square façade plates PC® SP150/150 mm are pushed into the insulation, providing the structure on to which the standing

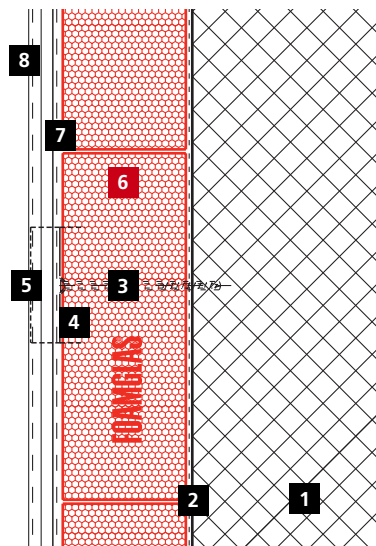

seams of the Tecu gold sheets can be folded and fixed 500 mm wide. A distinctive feature of the building is that the angles of the standing seams alternate from bay to bay, so the seams zig-zag their way across the face of the building. What's more, these seams wrap around the parapet and flow across the roof.

Shine on
FOAMGLAS® –
the resilient thermal
insulation
www.foamglas.ae

Build-up

- 1 Solid wall (concrete/brickwork)
- 2 Primer coat
- 3 Anchor bolt
- 4 Serrated fixing plates PC® SP 150/150 perforated
- 5 Fixing clips
- 6 FOAMGLAS® W+F slabs, adhered with PC® 56
- 7 Separation layer
- 8 Tecu gold standing seam





Cavity wall insulation

Texas A & M University at Qatar, Doha, UAE

Architect Halcrow

Construction 2005-2007

FOAMGLAS® application Cavity wall insulation

Texas A&M at Qatar is part of Education City, home to branch campuses of some of America's best universities and academic programs. The university offers undergraduate degrees in chemical, electrical, mechanical, and petroleum engineering.

A two layer brick wall does not provide a fully water and vapour proof external shell. High humidity and extreme heat can affect the thermal insulation between. With the use of FOAMGLAS® a material is applied which will never warp, sack or lose its performance over the whole life of the building.

FOAMGLAS® will remain dry and provides constant performance, is fully inorganic and will not support any fire. No flame spread and no smoke development.

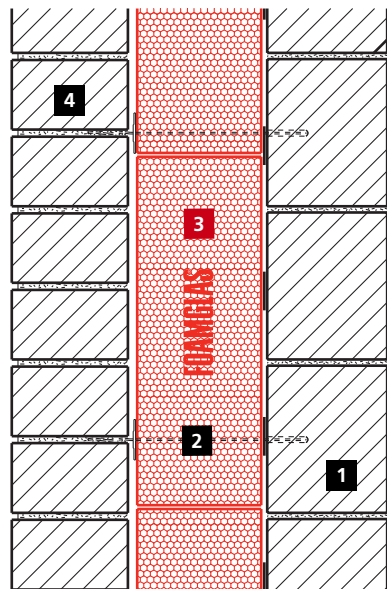

Risk reduction for non-accessible structural components

www.foamglas.ae

Build-up

- 1 Interior wall (brickwork/ concrete)
- 2 Wall tie
- 3 FOAMGLAS® WALL BOARD, bonded with PC® 56
- 4 Outer wall (brickwork)





Cladding,
prefabricated
coloured concrete
elevation panels

EDF Archives Centre, Bure (55), France

Architect LAN Architecture (75)

Client EDF (Electricité de France, electricity supplier)

Contractor Bové Bâtiment (88)

Construction 2010

FOAMGLAS® application Wall insulation

LAN Architecture has been awarded the International Architecture Awards 2009 for the EDF Archives Centre in Bure and Distinction by European Architecture Price 2012.

Further honoured in Germany by "Archi-BAU Awards 2009 – Green Building", the project has been recognised for its energetical qualities and its innovative façade. The façade, planned in association with BE Batiserf (38), has a very high performance and meets the energy standards of passive house construction. A combination of 2 layers of concrete (structure and facing) and 30 cm thick FOAMGLAS® W+F insulation ensures that the building has a high level of inertia, favouring comfort during the summer and reduces cooling requirements.

The concrete cladding elements are up to 19 m high and only fixed on the top and bottom side. FOAMGLAS® cellular glass is the perfect insulation for this type of environmental flagship project: thermal reliability for at least 30 years,

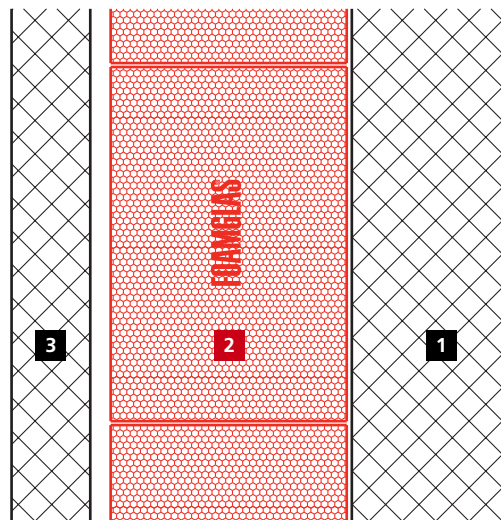

deformation-free, rigid and thick insulation blocks bonded to each other. The system provides:

- a maximum of insulation consistency and reduces thermal bridges
- best resistance to attack by rodents, insects, termites and
- full moisture/condensation control.

FOAMGLAS® – the thermal insulation to explore new ideas

www.foamglas.ae

- 1 Structural concrete
- 2 FOAMGLAS® W+F (monoblock, 300 mm thick), with PC® 56 adhesive
- 3 Cladding in prefabricated coloured concrete elevation panels. Suspension and anchoring system with cylinder





Cavity wall insulation

Cantonal school, Zug, Switzerland

Architect Enzmann + Fischer AG, ArchitektInnen BSA/SIA, Zurich

Construction 2003

FOAMGLAS® application Cavity wall insulation, about 2140 m², T4+ slabs, 40/200 mm thick, adhesively bonded

Outer shell Cast-in-place concrete (exposed concrete)

Twin-skin concrete constructions make high demands on the insulation material. The insulation layer is unapproachable later and has to be particularly robust to face a number of risks which include: the effects of high loading and moisture when the concreting for the outer shell is done as well as possible water infiltration through cracks and damaged joints during and after con-

struction. It is with good reason that FOAMGLAS® is called "safety insulation." Due to high compressive strength and imperviousness to moisture, it ensures that all the demands made on the insulation material are fulfilled with a performance that remains totally effective for the lifetime of the building.

Risk reduction for non-accessible structural components
www.foamglas.ae

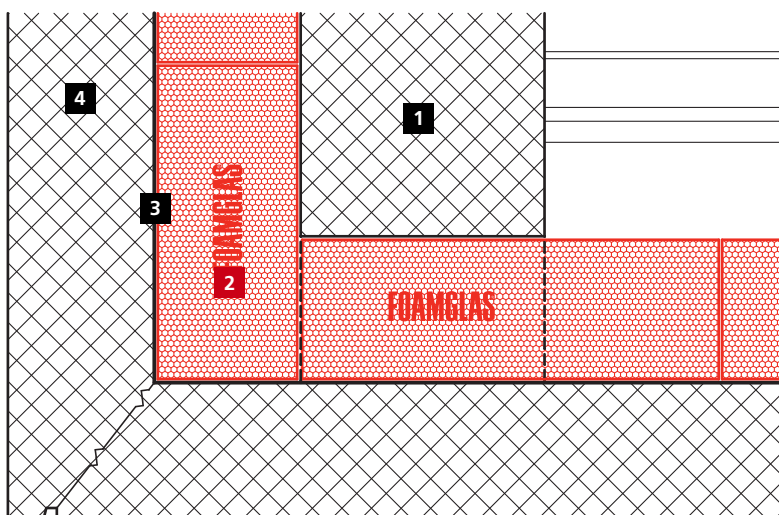

Façade structure

- 1 Structural wall, first floor
- 2 FOAMGLAS® T4+ slabs, adhesively bonded
- 3 Surface filler coating
- 4 Outer shell, exposed concrete





Cavity wall insulation

Resurrection Cathedral, Evry, France

Architect Mario Botta, Lugano

Construction 1989-95

FOAMGLAS® application Cavity wall insulation, about 2700 m², type Wall Board, 80 mm thick, mechanically fixed

External wall Claybrick from Toulouse, wall ties in stainless steel

During construction, the inner skin is installed first followed by the insulation, which often means that conventional insulation materials – susceptible to the uptake of moisture – are wet before the outer skin can be installed. Not so with FOAMGLAS®, which is an all-weather insulation and ensures dimensional stability and unaltered performance throughout the entire service life of the wall construction.

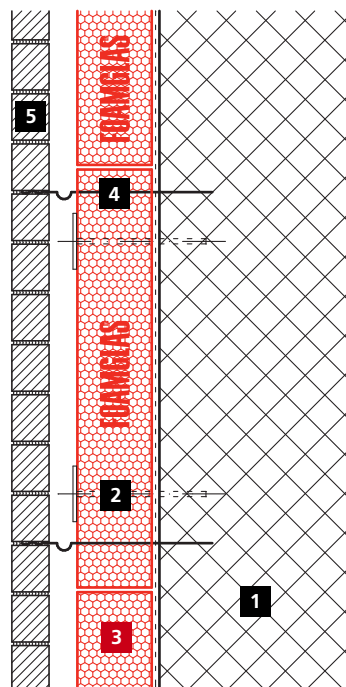

Weather-tight during construction

www.foamglas.ae

Façade structure

- 1 Structural concrete wall, inner skin
- 2 Wall tie
- 3 FOAMGLAS® WALL BOARD insulation
- 4 Mechanical fastening
- 5 External wall, outer skin





**Twin-skin
metal wall,
flat-locking
cassette system**

Swim Stadium, Stade Nautique de Saint-Raphaël (83), France

Architect Arcos (75)

Client City of Saint-Raphaël

Contractor SMAC (83)

Construction 2006

FOAMGLAS® application Twin-skin metal wall, WALL BOARD Alu T4+

The Water Stadium of Saint-Raphaël has an attractive design and was built to host the 2010 French Swim Competitions. The façade concept is based on a light steel construction with flat-locking ArcelorMittal panels, giving the facility a refreshing and accentuated character.

In the lightweight façade FOAMGLAS® insulation slabs are mounted on profiled metal sheets with vertical corrugation, which jointly support the outer cladding by the use of a z-purlin construction.

FOAMGLAS® thermal insulation is the unique solution for high humidity buildings to provide a long service life without ageing. FOAMGLAS® cellular glass insulation is unmatched in the inhibition of corrosion on twin-skin metal walls and achieves the requirements for sustainability and energy efficiency.

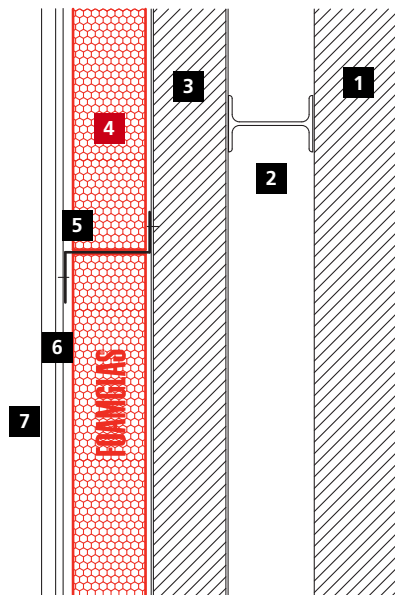

**FOAMGLAS®,
the resilient insulation
for high humidity
buildings –
a responsible choice**
www.foamglas.ae

- 1 Structural framework
- 2 Metal subconstruction
- 3 Steel sheet
- 4 **FOAMGLAS® WALL BOARD
Alu T4+ (80 mm thickness)**
- 5 Z-purlin subconstruction
- 6 Subconstruction to fix the
Isofran cladding
- 7 Isofran composite steel panel





Perforated cladding, stainless steel façade cassettes

Sully 3 Office Building, Loire-Atlantique District, Nantes (44), France

Architect Forma6 (44)

Owner Conseil Général de Loire-Atlantique (General Council of District L-A)

Contractor Sofradi (44)

Construction 2009

FOAMGLAS® application Façade, WALL BOARD W+F

Forma6 architects have conceived an innovative façade for the office building Sully 3 of the General Council of the Loire-Atlantique District in the city of Nantes. The cladding is made up of stainless steel panels, into which an openwork pattern is laser-cut like an embroidery.

The use of FOAMGLAS® cellular glass insulation behind the open cladding ensures reliable thermal performance on the façade and allows this type of construction without the need for an additional rainscreen and its technical disadvantages. For this application FOAMGLAS® W+F boards were covered with a black fibreglass mat to comply with the façade's aesthetics.

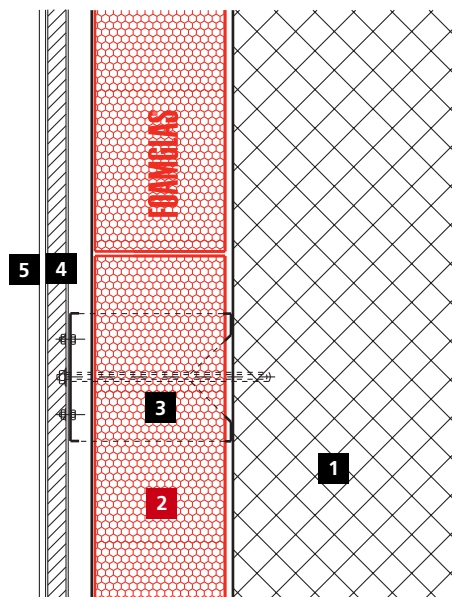

FOAMGLAS® insulation – to face today's architectural challenges
www.foamglas.ae

- 1 Structural wall (concrete)
- 2 FOAMGLAS® WALL BOARD W+F, lined with a black fibreglass mat
- 3 U-shaped fixing bracket and spacer Foamfix
- 4 Metal subconstruction
- 5 Stainless steel cassette cladding





Ventilated open screen cladding

Water supply works 'Seewasserwerk', Männedorf, Switzerland

Architect Theo Hotz AG, Zurich

Construction 2005

FOAMGLAS® application Façade insulation, about 630 m², T4+ slabs, 100 mm thick, adhesively bonded

Façade cladding Wire mesh

See-through wire mesh as the external skin is of aesthetic value only; it does not provide protection against driving rain or environmental conditions. The layers beneath the wire mesh must fulfil the function of both weather-tightness and insulation of the building. FOAMGLAS® insulation with sur-

face filler finish does not require additional waterproofing sheets. The coated FOAMGLAS® system is resistant against any weathering conditions, including UV resistance, and moreover meets the surface design requirements behind open wire mesh.

Longterm protection against moisture

www.foamglas.ae

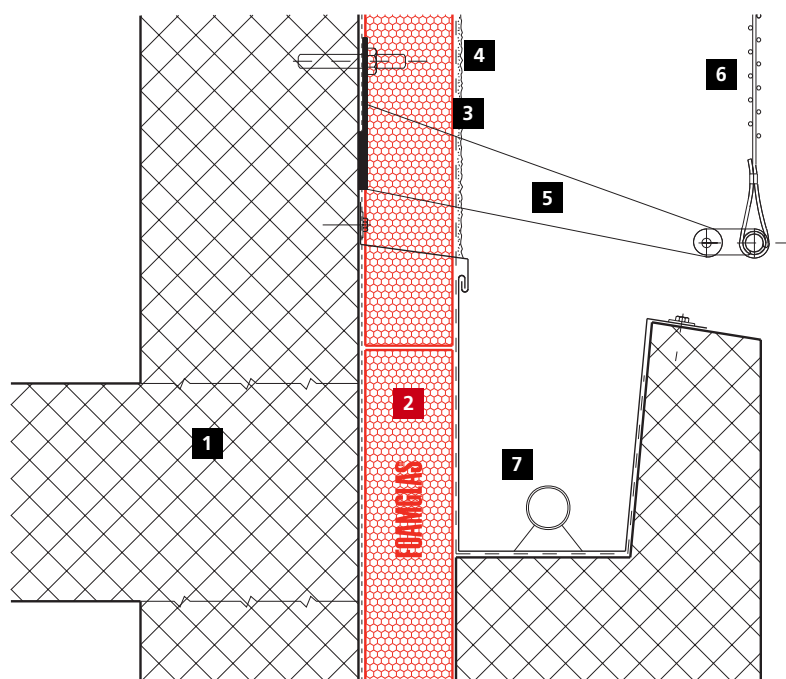

Façade structure

- 1 Concrete structure
- 2 FOAMGLAS® T4+ insulation, adhesively bonded
- 3 Surface filler coating with reinforcement fabric
- 4 Special render coat
- 5 Clamping device
- 6 Wire mesh
- 7 Lightning





Rainscreen cladding,
aluminum
profiled sheets

STEP, La Riche (37), France

Client Urban Community Tours Plus

Contractor Barco Etanchéité (45)

Construction 2005

FOAMGLAS® application Reservoir insulation, T4+ slabs

Cladding Corrugated aluminum cladding

Conditions with high moisture levels require optimal thermal insulation. Insulation and vapour barrier systems should give proven reliability, otherwise there are risks that vapour migration, condensation and corrosion may cause significant damages in the vertical building shell. FOAMGLAS® cellular glass insulation is an ideal material as it performs conjointly as a thermal and vapour barrier. Made of glass, the insulation is totally impermeable to all kinds of damp, vapour and gases. Thermal ageing does not take place and thus it has proven long term resilience. The three digesters of the wastewater treatment plant in La Riche received a durable external insulation, cladded with profiled aluminum sheets.

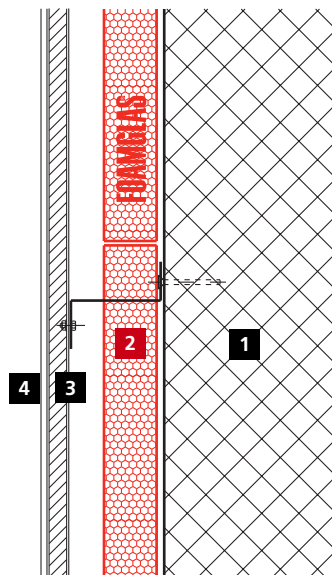

FOAMGLAS® –
the 100 % mineral
insulation provides
full water- and damp-
proofing capacities to
decrease corrosion
www.foamglas.ae

- 1 Substructure
- 2 FOAMGLAS® T4+
(60 mm thickness)
- 3 Subconstruction
- 4 Profiled aluminum cladding
(vertical corrugation)





1 Industrial building, cold store.

The ideal solution in terms of building physics

The thermal and physical demands on the external walls of a building are extremely high and conditioned by the environment, the structural design and the use of the building. Different physical interactions occur and various functions have to be fulfilled, all of equal importance to the structure as a whole. What are the weathering, the temperature and the nuisance conditions for the building? How do we achieve a comfortable indoor climate for the occupants without undesirable effects? Whatever the conditions are, FOAMGLAS® provides an optimal solution.

Considerations regarding the quality and durability of buildings

Traditional fields of building physics are thermal insulation, protection against moisture, sound proofing and fire safety. The elimination of undesirable physical interactions is most important for the quality of the building and healthy living conditions. Determinants are – in addition to economic issues – system performance, service life, indoor climate, energy efficiency and environmental impact. The target of building physics is to improve the living conditions for the occupants

and to protect the building against undesirable effects. At that thermal insulation plays a key part.

Particularly with regard to the growing interest in low-energy houses, thermal insulation and energy-saving technology is of primary importance. Thicker insulation on all enclosure surfaces is certainly an important step to be taken, however the wall structure has to be designed and fitted accordingly, in particular at door and window openings.

Inadequate thermal insulation should not be underestimated, as it may not

only cause heat loss but constitute a serious risk for the building's structure itself. Well designed thermal insulation significantly saves energy costs and provides protection against damage on the building.

Avoidance of cold bridging

Ventilated rainscreen cladding systems appear to be a safe solution in view of building physics. With the right choice of materials and design, the rainscreen

results from a three-dimensional program. As a result: The support and fixing method has a considerable influence on the overall insulation value of the rear ventilated façade. A high level of heat loss has been seen, about 13–80% dependent on the type of construction and the materials (see figures "Heat losses" on pages 26/27). This undesirable effect is maximized with growing insulation thickness – which obviously correlates with heavier structural fasteners.



cladding can efficiently provide protection from the effects of weather in the long term and enable the most imaginative scheme to be realised. As a rule, cold bridging should be avoided. These weak points are created where mechanical fasteners for the suspension of the rainscreen cladding have through-fix anchoring which generate additional energy loss.

A number of studies – for example by EMPA Dübendorf (Swiss Material Testing Institute) – have been made to evaluate the heat loss that occurs in many wall constructions because of the structural support element for the cladding passes through the thermal insulation and onto the load bearing structure. Measurements from field studies for different façade systems were compared to computational

For energy policy reasons, the trend towards thicker façade insulation is increasing not only in Switzerland, but Europe wide. It is absolute necessity to develop new, innovative and energy-efficient solutions. The Swiss 'Bundesamt für Energie' (BFE, Federal Office for Energy) and 'Fachhochschule Nordwestschweiz/beider Basel' (FHNW/FHBB, University of Applied Sciences Northwestern Switzerland) took the initiative and invited the industry to an idea contest. In the beginning of 2000 ten teams were selected to develop the subject "Thermally optimised structural support elements for ventilated rainscreen cladding systems". The FOAMGLAS®-team obtained the first price with enterprise allowance for the new cladding support system FOAMGLAS®-plus.

Heat losses as percentage for different structural support elements

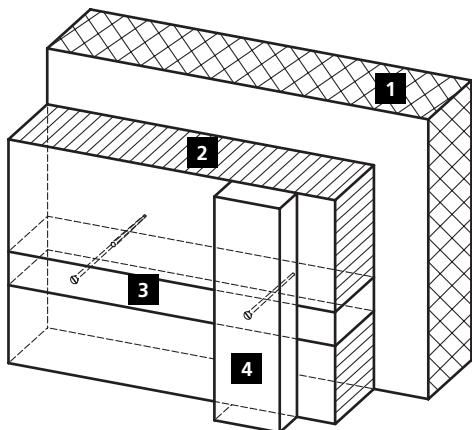

Timber lathing¹

- 1 Structural wall
- 2 Thermal insulation
- 3 Support lathing through the insulation
- 4 Façade support lathing

+21%

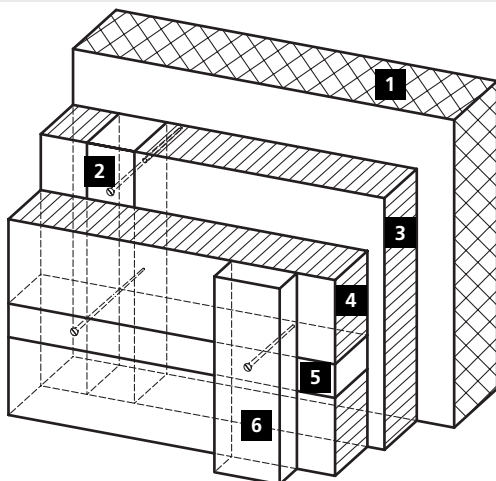

Timber lathing, crosswise¹

- 1 Structural wall
- 2 Support lathing through the insulation
- 3 Thermal insulation – layer 1
- 4 Thermal insulation – layer 2
- 5 Secondary lathing
- 4 Façade support lathing

+13%

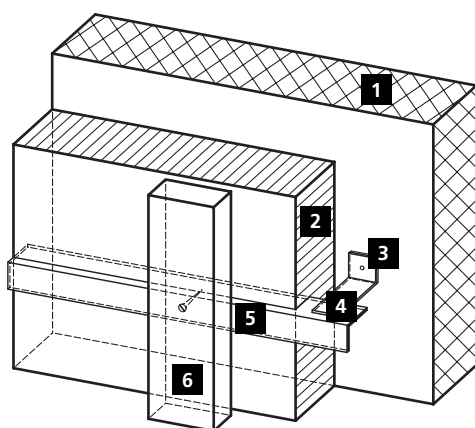

Steel brackets and angle profiles¹

- 1 Load bearing wall
- 2 Thermal insulation
- 3 Decoupled buffer
- 4 Fixing bracket
- 5 Façade load bearing metal profile
- 6 Support lathing

+17%

¹ Source (values and systems): Richtlinie "Bestimmung der wärmetechnischen Einflüsse von Wärmebrücken bei vorgehängten hinterlüfteten Fassaden", EMPA, Ausgabe 1998 (Code of practice "Heat losses as percentage due to cold bridging and air leaks", EMPA, edition 1998).

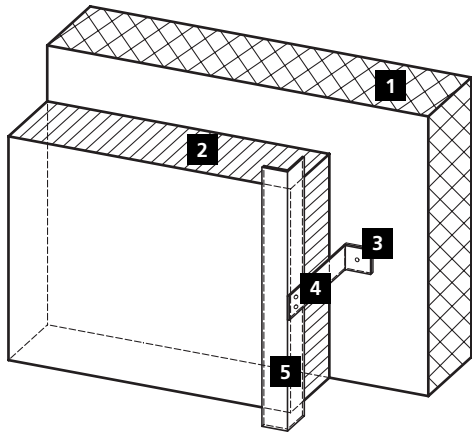

Aluminium brackets and aluminium angle profiles¹

- 1 Load bearing wall
- 2 Thermal insulation
- 3 Decoupled buffer
- 4 Fixing bracket
- 5 Aluminium steel support for the façade

+ 28 %

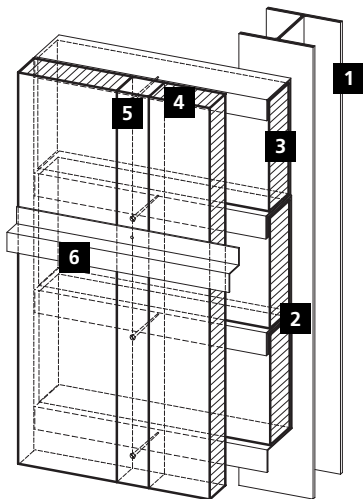

Metal cassette wall and two layers of insulation²

- 1 Supporting steelwork
- 2 Metall cassette
- 3 Thermal insulation – layer 1
- 4 Thermal insulation – layer 2
- 5 Timber or metal support
- 6 Metal façade fixing profile

+ 80 %

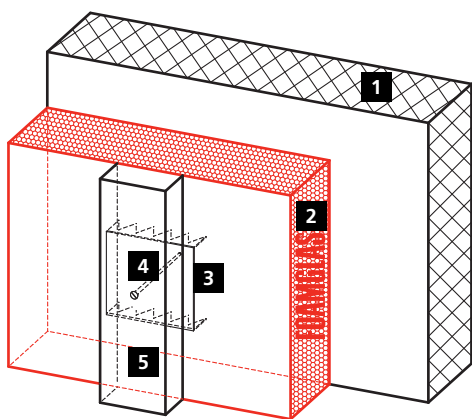

FOAMGLAS[®]-plus façade³

- 1 Load bearing wall
- 2 FOAMGLAS[®] T4+ slabs
- 3 Metal fixing plates (claw plates)
- 4 Bolt/screw connection to the main structure
- 5 Metal/timber support structure for the façade

+ 4 %

- 1 Source (values and systems): Richtlinie "Bestimmung der wärmetechnischen Einflüsse von Wärmebrücken bei vorgehängten hinterlüfteten Fassaden", EMPA, Ausgabe 1998. (Code of practice "Heat losses as percentage due to cold bridging and air leaks", EMPA, edition 1998).
- 2 Source (values and systems): "EMPA-Schlussbericht F+E" Nr. 127378: Hinterlüfteten Fassaden. (EMPA final report Nr. 127378: Ventilated façades).
- 3 Source (values and systems): "Wärmebrücken aus kraftschlüssiger Verankerung von hinterlüfteten Fassaden-Bekleidungen", Weder + Bangerter AG, Ingenieure und Fachverlag, www.baudaten.com (Cold bridges from through-fix anchoring of rear ventilated façade systems).

The FOAMGLAS®-plus system

This new concept for rainscreen cladding support reduces cold bridging and achieves best overall insulation values for ventilated façades. By use of high compressive strength FOAMGLAS® insulation adhesively bonded to the structural wall and placement of the metal fixing plate/claw plate – or T-console for heavier façade systems – to support the subconstruction/cladding in front of the insulation, a system is available that minimises cold bridging.

The new façade system FOAMGLAS®-plus works with the following components:

- The self-supporting insulation in high-compressive strength FOAMGLAS® is adhesively bonded to the load bearing wall and forms a totally integrated surface, without effects of heat losses and air leaks. (Joints are closed and water-tight, additional support for the insulation is provided at window/door lintels and at the base of the wall by use of angle bars).
- Metal fixing plates (U-shaped claw plates in galvanized steel) are pressed on to the FOAMGLAS® surface, adhesively bonded and mechanically fixed to the structure. The fixing level for the ventilated rainscreen cladding is placed on the upper side of the insulation, an installation method, which creates minimal cold bridging.
- Metal fixing plates (claw plates) and bolt/screw connection to the main structure allow for a safe mounting of conventional façade support structures (in timber, metal) to bear the cladding elements. The system is designed for lightweight to medium-heavy cladding elements of small, medium or large size.

Adhesively bonded facing elements/bricks on FOAMGLAS® insulation

By the thermally optimised mechanical fixing of the support structure for rainscreen cladding – due to the FOAMGLAS®-plus system – remarkable improvements on the overall insulation value of the ventilated façade can be achieved.

Absolutely best performance without heat losses – for a minimized thickness of the façade structure – can be achieved without any through fixings. A façade structure excluding all cold bridges is possible when the outer leaf is directly bonded to the insulation. FOAMGLAS® insulation is the robust and versatile material that has the required properties for this type of building solution.

Air tightness of insulation and system

Air tightness of the system is achieved by the closed cellular glass structure of FOAMGLAS® and the adhesively bonded insulation layer itself with sealed joints. The installation method minimizes any risks from interstitial condensation. Heat losses due to the effects of air flow on insulants with low resistance to the passage of air, will not take place with the FOAMGLAS® system.

Use of FOAMGLAS® insulation allows for a totally integrated surface without the need to cut lengths around anchors and to stuff openings against air leaks.

FOAMGLAS® has best dimensional stability. It will not warp or sag and cannot create any blockage of the rear ventilation space. It remains stable under all conditions of use and temperature fluctuations and moisture will have no adverse effects. Butt-pressed and adhesive sealed joints ensure the structural stability of the system in the long-term; there will be no danger of air leaks and additional heat losses to develop in the course of time.

Bad workmanship and unsuitability of materials can have a dramatic effect on the thermal insulation values, particularly with cladding systems. In how far faulty workmanship on insulation has influence on the percentage of heat loss caused by cold bridging, has been shown by EMPA studies on ventilated façades (see pictures below). Additional heat loss caused by cold bridging can vary considerably in function of the quality level of workmanship. In case of air circulation around the insulation board, the heat loss from thermal transmittance can bump up to a considerable degree.

Heat losses as % due to cold bridging and air leaks

Source: EMPA, Schlussbericht F+E Nr. 127378 [Final report F+E Nr. 127378]

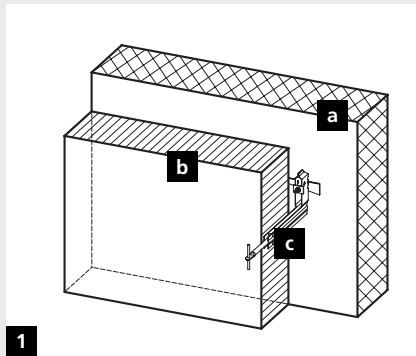

1 Anchoring system: Suspension and fixing systems

- a Load bearing wall
- b Thermal insulation
- c Single structural fastener

The quality of the workmanship on site can influence the heat losses by up to **30 %** (due to air leaks through the notches around fasteners in fibre wool insulation)



2 Ideally the structural fastener is perfectly encased

+34%



3 In practice the encasement of structural fasteners is less perfect

+50%

FOAMGLAS® ensures that all physical and thermal demands are fulfilled

- FOAMGLAS® provides groundbreaking system solutions that significantly reduce the likelihood of cold bridging.
- The FOAMGLAS®-team draw first prize for the new façade insulation system FOAMGLAS®-plus, following a call for proposal by Swiss Federal Agency for Energy.
- FOAMGLAS®-plus: By use of metal fixing plates/claw plates applied to the insulation surface, the fixing devices for the subconstruction and cladding elements are positioned in front of the insulation layer, thus greatly reducing cold bridging.
- Another construction variant allows facing elements/bricks to be directly bonded to the FOAMGLAS® surface. This solution provides a totally cold bridge-free façade structure. FOAMGLAS® has the product qualities to fulfil the specific requirements of this system.
- FOAMGLAS® cellular glass insulation is totally air tight and the adhesively bonded slabs with closed joints ensure as well for structural integrity and optimal air tightness of the system.
- High density and dimensional stability of FOAMGLAS® add to the structural stability of the whole cladding concept and ensure that the insulation will not warp or sag when the building work is complete.



- 1 The spread of fire across the façade and the roof can contribute to devastating total loss.

Fire protection

After fire disasters heated discussions are aroused regarding responsibilities and fire precautions. Closer examination puts the question if the fire and the development of dangerous fumes could or should not have been prevented? The part played by insulation materials is a frequent issue. Studies provide clear evidence: FOAMGLAS® contributes to efficient passive fire protection. Cellular glass is non-combustible and does not give off fumes or toxic gases.

served – because of the scale of the fire and the degrees of heat. The unfortunate coincidence of different factors can be the cause, as for instance a high fire load on the inside of the building, rapid spread of fire effluents, high wind and difficult access to the seat of fire. Reports of fire and rescue services can speak volumes ...

All the more care and attention has to be given to passive fire protection. By choosing adequate construction materials the risks of fire development – in particular the spread of fire across voids and flammable materials – can be reduced significantly.

Preventive action starts with the choice of materials

"Fire disaster ... fire safety provisions violated ... two victims are still fighting for their lives ... there is evidence that fire safety regulations have been ignored ... rapid propagation of the fire has been encouraged ... sea of flames."

These headlines make evident: To extinguish a fire in a building is sometimes rather difficult – even if building regulations on fire safety have been ob-

Smouldering fires – extraneous perils

Fires of this nature generally spread inside construction elements where they may go undetected for a long time. Sometimes hours may pass by between ignition and detection of the fire.

The specific structural and chemical characteristics of some insulants increase the risk of smouldering fires. This is not the case with FOAMGLAS®. The all glass closed cell structure of the insulation forms a shield.

FOAMGLAS®: Neither fumes nor toxic gases

Fire disasters must not always be identical with "a sea of flames". Have a flashback to the events on Düsseldorf Airport (1996) with 17 casualties and the fire in the Montblanc Highway Tunnel (1999), which caused the death of 39 people. In both cases toxic effluents from insulants, that were not fire safe, were considered responsible for the fatality (polystyrene in Düsseldorf, polyurethane at the Montblanc rock).

ASTM

By contrast FOAMGLAS®, it does not give off fumes or toxic effluents. In respect of fire safety FOAMGLAS® is classified non-combustible. The material with its all glass closed cell structure does not contain any binders. This is established according to ASTM E 136 and Euroclass A1. FOAMGLAS® provides real benefits in terms of fire safety. ASTM E 84 attests a smoke development of 0 and UL Building Materials Directory, a flame spread of 0.

Regarding fire safety FOAMGLAS® performs unlike all other insulants, classified as "non-combustible". The big difference is that FOAMGLAS® does not glow or smoulder and does not cause the spread of fire across the construction.

FOAMGLAS® melting point > 1000 °C

According to german DIN 4102-17 the melting point of FOAMGLAS® was tested at MPA Braunschweig Institute (D). More than 50% of the insulation thickness lasted the 90 minute fire period without significant damage. As an official result the melting point is >1000 °C.

General protection with FOAMGLAS® in case of fire: Melt Shield-Effect

Comparable as a thermal protection shield the melted glass surface of the flame treated area is protecting the

lower cell structure. The temperature on bearing structure is remaining low. FOAMGLAS® is defending the building structure in case of fire.

To play safe: FOAMGLAS® for insulation

Recent fire testing yielded that cellular glass has excellent fire control attributes. Relevant test certificates are available from the national FOAMGLAS® subsidiaries. With regard to recent findings in preventive fire protection, architects and clients should redefine their safety requirements, which should be geared towards low-risk management for the façade structure under fire conditions.

If it is about quality standards in building, it makes sense to consider as well appropriate fire safety measures. Fire inquests are supposed to demonstrate the need to builders that the demands

on fire safety should clearly be defined at an early stage in cross-functional cooperation of planning offices/architects, contractors and the client himself.

- 1 Fire in an apartment house.
- 2 Fire and toxic effluents from a warehouse incident.
- 3 Conclusion after test procedure: FOAMGLAS® melting point > 1000 °C.



FOAMGLAS® provides superior performance regarding preventive fire protection

- FOAMGLAS® is a safer product as it is pure and non-combustible cellular glass insulation. Reaction to fire classification: EN standard, Euro Class A1, Technical Agreement by VFK Nr. 5273).
- FOAMGLAS® thermal insulation performance is unaltered when exposed to extreme temperatures. The material does not soften up to 430° C and does not sag.
- Closed cell FOAMGLAS® insulation prevents oxygen to pass through the material to tease the trouble spot.
- FOAMGLAS® is gas-tight. The passage of hot gases through the insulation and their development inside the insulant is to be excluded. FOAMGLAS® is a safety insulation that forms a barrier against the propagation of the fire.
- Vapour-proof FOAMGLAS® does not need any additional protective layer, type vapour control layer. This means that the fire load is insignificant when compared with other insulants.
- FOAMGLAS® does not develop any flammable combustion residues, fumes or toxic effluents which can be harmful to health.

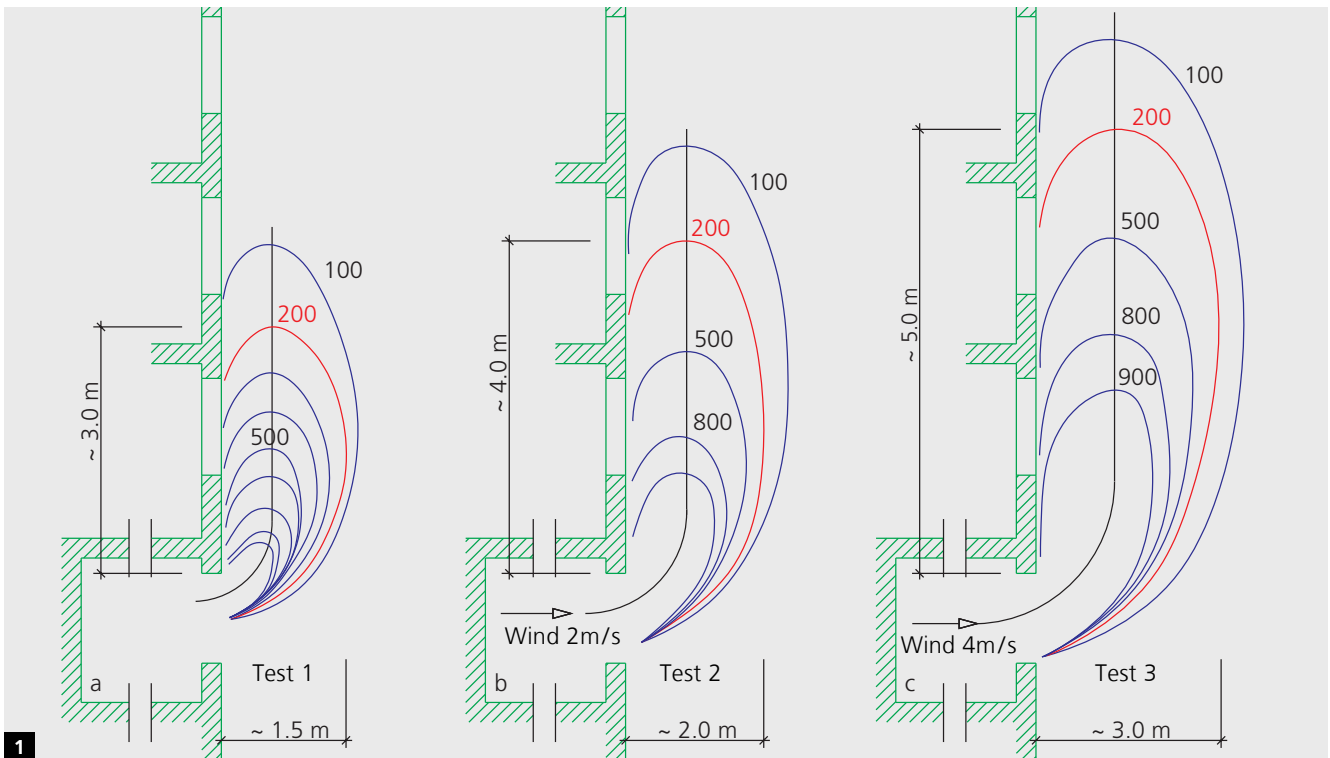

1 The figure shows the existing temperatures on a façade for three fire test set-ups under large-scale fire conditions.



- 1 The long-term performance of the insulation is decisive for financial efficiency in building.

Durability is the key to economy

Successful property developers and house-builders plan ahead while taking investment decisions. Not the first low-priced solution that comes along is given the preference, but cost-efficiency in the long-term which yields a good return of investment pays out to be most profitable. This means that the protection of the fabric of the building, quality materials for the enclosure walls and a greater versatility in use for the interior surfaces are the main demands. With regard to energy efficiency the insulation material should provide a performance that remains totally effective for the lifetime of the building. FOAMGLAS® is able to fulfil these demands and moreover achieves the best useable floor ratio. The design structure of the insulated walls can be slimmer than for other insulation materials, which creates more useable space within the building structure.

Secret qualities

Be it residential, commercial, industrial or public constructions: the quality of the insulation system for the roof and the façade is decisive for the service life of the building's structure. As with the flat roof it can be shown for the façade that long-term efficient constructions are more economical than cheap solutions. The façade of a build-

ing fulfils an important function: it needs to protect the fabric of the building from the effects of weather – cold, heat and rain. A wide range of aesthetic cladding materials in a great number of colours and shapes, including concrete, bricks, ceramics, natural stone, metal, fibre cement and many others, can be used. Usually they can protect a building for a period between 10 to 50 years or even longer. Often it is not the cladding that is the weakest link in the chain, but the thermal insulation.

Due to the effects from moisture, temperature fluctuations, wind and environmental pollution, the service life of many an insulant is shorter than that of the cladding material. Loss of structural integrity – warping and sagging – of the insulation material, which is exposed to climatic changes, will affect its performance and compromise the structural stability of the whole cladding concept.

This is not the case with FOAMGLAS®: The all glass closed cell structure of the insulation remains stable under all conditions of use. With high compressive strength it is robust against all sorts of stresses. FOAMGLAS® remains totally effective for the lifetime of the building.

Unaffected, constant thermal insulation value over decades

Moisture absorption, loss of structural integrity and the passage of air on façades are nightmare scenarios. Quality loss on badly affected insula-

tion material results in considerable heat losses. Extensive repair works will become necessary. In particular with regard to today's greater insulation thicknesses, heat losses will be a major cost factor.

Due to the specific FOAMGLAS® properties – i.e. the impermeability to moisture, the structural stability – and the bonded installation method which protects against air leaks, a totally integrated surface is created which ensures efficient protection against serious damage.

To conclude: FOAMGLAS® insulation function and value will remain constant for decades; its sustainable performance plays a key part when high standards are required.

No ventilation space – gain in useable space within the building structure

As FOAMGLAS® is impervious to moisture, no rain will wet the insulation on the weather side and no vapour transport will affect it from the room side. This means significant advantages. In summer there is no need for a ventilation space to allow interstitial condensation to "escape" .

Use of FOAMGLAS®-plus façade substructures dispenses with the need for a ventilation space and greatly reduces heat loss from cold bridging. The FOAMGLAS® rainscreen cladding system allows to gain several centimetres on the façade structure. This gain in useable space, calculated for the number of floor levels in the building, totals in a substantial gain in space.

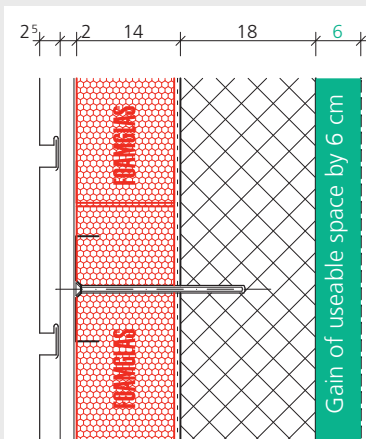

Façade structure based on FOAMGLAS®-plus substructure and FOAMGLAS® insulation slabs, type T4+, 140 mm thick, provides a U-value of 0.26 W/m²K

Gain of useable space by 6 centimetre for a façade structure with an identical U-value, because:

1. Minimal heat losses due to the metal plate system
2. Minimal space required for the installation of the cladding (no ventilation space required)

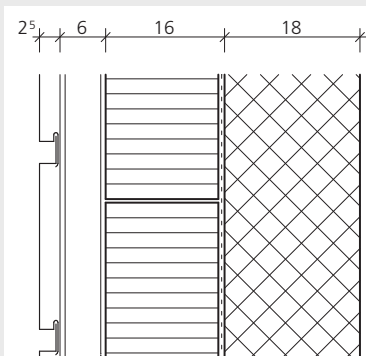

Conventional cladding system using wool insulation and aluminium steel support for the cladding, including a thermal buffer, provides a U-value of 0.26 W/m²K

FOAMGLAS® – a new dimension in performance + economy

- Building with FOAMGLAS® is preferring a durable and cost-efficient solution instead of a low-end solution.
- FOAMGLAS® offers high structural stability (dimensionally stable) and is resistant to damage from demanding environmental conditions.
- Energy-efficiency in building requires an insulation material where insulation function and value will remain constant for the service life of the building. There is but one: FOAMGLAS®.
- Due to its outstanding physical qualities FOAMGLAS® perfectly resists to moisture, temperature fluctuations, passage of air, environmental pollution etc. and therefore obviates building refurbishment.
- FOAMGLAS® allows for exacting insulation values over decades, a most important item for buildings according to high energy standards like Swiss 'Minergie-' and 'Minergie-P-Standard'.
- The FOAMGLAS® system dispenses with the need for rear ventilation with rainscreen cladding – this gives the advantage of more useable space within the building structure.



Excellent Ecological profile

FOAMGLAS® insulation systems are stable under all conditions of use and protects the owner from unexpected expenditures for heating or expensive replacement of the insulation or repair. FOAMGLAS® systems safeguard the environment one way or another. They allow for energy saving and, from the cradle to the grave, they do not contribute to environmental pollution, a safe product consistent with the principles of building physics. Cellular glass is certified to standards of health and indoor air quality. Ecologically viable product recycling is possible in the case of building demolition.

Typically 60%+ of the raw material is recycled glass. A very low percentage of carbon is added during manufacturing which makes the charcoal grey color of the insulation. In the cellulating furnace the soft, viscous glass is foamed through release of carbon dioxide (CO₂) and forms millions of airtight glass cells enclosing the gas. This closed cell glass structure ensures full resistance to the transmission of vapor (resistance to water vapor transmission $\mu = \infty$).

Production and composition

FOAMGLAS® manufacturing is two sub-processes. In the first part of the process the recycled glass is melted and subsequently batched with the remaining raw materials and crushed in a mill. In the second sub-process the powder mix passes in the cellulating furnace at high temperature where FOAMGLAS® cellular glass is foamed – comparable to the process of fermentation in bread baking.

- 1 Renewable energy sources are increasingly used in FOAMGLAS® production.
- 2 FOAMGLAS®: millions of airtight glass cells.



Environmentally friendly production

The raw materials used in the FOAMGLAS® production are inherently mineral and thus environmentally friendly. Principal raw material is recycled glass. Further raw materials are feldspar, sodium carbonate, iron oxide, manganese oxide, carbon, sodium sulfate and sodium nitrate. By the introduction of recycled glass into the production FOAMGLAS® makes a relevant contribution to the protection of the environment.

Minimal environmental pollution

Due to improvements in process engineering and in the energy supply (coming from hydro electric energy and wind turbines) significant progresses has been achieved in recent years regarding air pollution, greenhouse gas emissions, consumption of energy and resources:

- The demand for non-renewable energy was reduced 4.24 kWh/kg.
- Greenhouse gas emissions have been halved.
- The percentage of recycled glass was progressively increased from 0 % to 30 and to 60 %.
- The environmental pollution score (UBP97) was reduced from 1619 to 743 points.
- The eco-indicator (EI99 H, A) dropped from 0.13 to 0.09 points.

Reduction of the production energy means that the time period for energy amortization of the investment in thermal insulation – as an important evaluation unit – is considerably reduced.

FOAMGLAS® manufacturing (Tessenderlo Plant, Belgium)

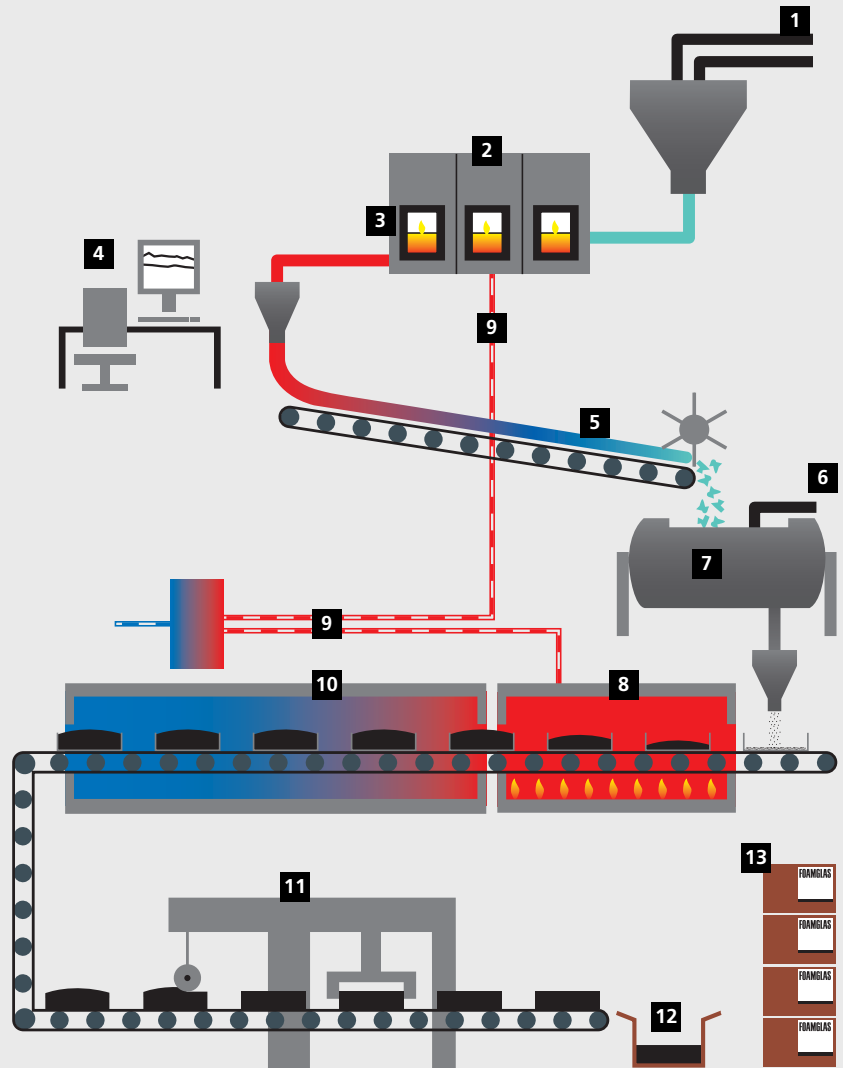

- 1 Mixing and batching of the raw materials: Recycled glass, feldspar, sodium carbonate, iron oxide, manganese oxide, sodium sulphate, sodium nitrate.
- 2 The melting furnace has a constant temperature of 1250°C.
- 3 Molten glass is drawn out of the furnace.
- 4 Control room for monitoring the production.
- 5 The glass is drawn off and falls onto the conveyor band where it cools down before entering into the ball mill.
- 6 Addition of "carbon black".
- 7 Ball mill grinds all ingredients into a fine powder before putting into stainless steel moulds.
- 8 The filled moulds pass through a cellulating oven (Foaming furnace) with a temperature of 850°C. This is where the material gains its unique cell structure.
- 9 Energy recovery of heat.
- 10 The FOAMGLAS® blocks pass through an annealing oven to allow carefully controlled cooling of them without thermal stress.
- 11 The blocks are cut to size and sorted by batch. Production waste is recycled.
- 12 FOAMGLAS® slabs are then packaged, labelled and palletized.
- 13 Finished FOAMGLAS® products are stored and prepared for transport.

FOAMGLAS® stands comparison

The environmental pollution score (UBP 2006**) for the production and waste disposal of FOAMGLAS® is 903 points/kg (insulation). This puts FOAMGLAS® into the pole position in eco-balance. Other insulation products show points between 2020 (stone wool) and 8490 (Extruded polystyrene).

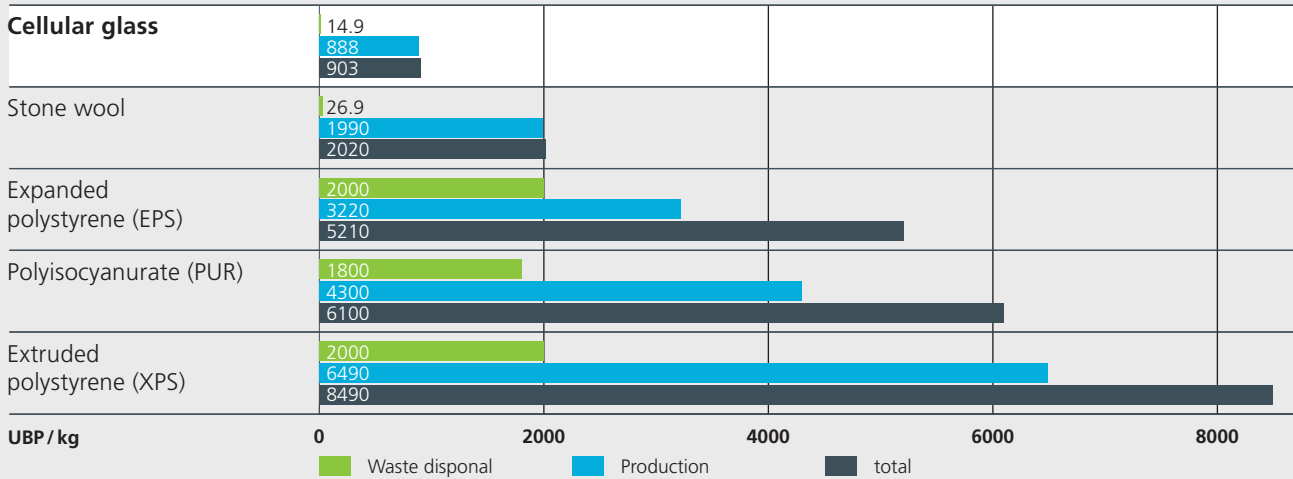

Compared to surfaces, with a specified insulation value of 0,20 W/m²K, FOAMGLAS® performs very well. The environmental pollution score (UBP 2006**) of cellular glass is 17 157 points (FOAMGLAS® W+F), 21 807 points (FOAMGLAS® T4+) per square meter. Other insulation products show 23 790 points (PUR), 26 571 points (EPS), 46 056 points (stone wool) and 53 232 points (XPS) for an identical U-value (see table).

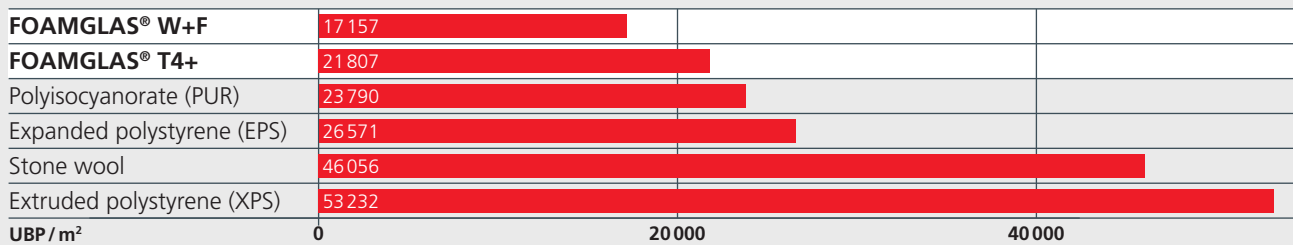

Insulation	?	?D*	d	weight per m ²	UBP* per kg	UBP per m ²
	kg/m ³	W/mK	m	kg/m ²	UBP/kg	UBP/m ²
FOAMGLAS® T4+	115	0.041	0.21	24.15	903	~ 21 807
FOAMGLAS® W+F	100	0.038	0.19	19.00	903	~ 17 157
Polyisocyanurate (PUR)	30	0.026	0.13	3.90	6100	~ 23 790
Stone wool	120	0.038	0.19	22.80	2020	~ 46 056
Expanded polystyrene (EPS)	30	0.034	0.17	5.10	5210	~ 26 571
Extruded polystyrene (XPS)	33	0.038	0.19	6.27	8490	~ 53 232

* The data are taken from building database KBOB/EMPA, June 2009.

** The environmental pollution score (UBP 2006) quantifies the pollution coming from resources, water consumption, emissions into air, water and ground and also for the waste disposal. The environment pollution through grey energy and global warming are included in the UBP score.

World resources

The principal raw material of FOAMGLAS® production today is selected recycled glass (in the past the main raw material was silica sand). The supplies of recycled glass are ample, as in the construction and other industries large quantities amass and have to be disposed of as waste. Plastic foam insulation, however, is produced from crude oil, which is a non renewable fossil fuel.

FOAMGLAS® cellular glass insulation products now with natureplus label

Natureplus, an international organisation for the development of a culture of sustainability within the building sector, has selected cellular glass thermal insulation from Pittsburgh Corning Europe SA as a green building product and awarded the natureplus quality label. "Cellular glass thermal insulation by Pittsburgh Corning Europe SA ideally meets the quality requirements for a sustainable construction product", noted Uwe Welteke-Fabircius, president of natureplus e.V., when handing-in the certificate. The natureplus quality seal is the symbol of recognition for building products with a high level of quality in the areas of health, the environment and functionality. Pittsburgh Corning's FOAMGLAS® types W+F, T4+, S3 and F from the Tessenderlo plant (Belgium) are tested and certified successfully.

Service life

Having outstanding qualities (mineral, impermeable to water and vapor, resistant to acids, non-combustible, high-temperature resistant), cellular glass is a very durable material. The long service life of the material has very positive effects, ecologically and financially, on the service-life of the construction and, consequently, on the life of the building. Maintenance and replacement cycles can significantly be reduced by the use of durable materials.

Emissions / nuisance during installation and use

Cellular glass does not release harmful or toxic components into the environment. It does not contain green house gases or ozone depleting products, no flame retardant and no con-taminative or carcinogenic particles and fibers. When recommended installation instructions are followed, cellular glass insulation does not produce emissions that degrade the environment or health, at production, installation nor use.

Emissions in case of fire

Dumping and burning of construction waste is most critical for the environment, even in small quantities. In particular plastic foam materials are classified as harmful. In the case of burning of these materials high levels dangerous emissions are released than in combustion in an incineration plant. Studies have been conducted in Germany on

thermal combustion of polystyrene insulation, which clearly indicated that released fumes are acutely toxic. Serious adverse health effects in the long-term cannot be excluded. Even with combustion in a waste incineration plant, there is high impact to the environment, as annually several thousand tons of slag and filter residue have to be transported to special disposal sites. The non-combustibility of cellular glass makes the toxicity issues irrelevant.



natureplus – The European quality seal for approved green building products.

Ecological assessment for different thermal insulation materials							
	Production energy	Resources	Nuisance for workers	Emissions during production	Emissions in case of fire	Long-term performance	Disposal / Recycling
Glass wool	Yellow	Yellow	Orange	Yellow	Yellow	Orange	Orange
Stone wool	Yellow	Yellow	Orange	Yellow	Yellow	Orange	Orange
Cellulose insulation	Yellow	Yellow	Yellow	Yellow	Yellow	Red	Yellow
Pure expanded cork	Yellow	Red	Yellow	Yellow	Orange	Orange	Yellow
Expanded polystyrene	Orange	Red	Yellow	Yellow	Orange	Orange	Orange
Extruded polystyrene	Orange	Red	Orange	Yellow	Orange	Orange	Red
Polyurethane (PUR)	Orange	Red	Orange	Yellow	Red	Orange	Red
FOAMGLAS®	Yellow	Yellow	Yellow	Yellow	Yellow	Yellow	Yellow

Very good
Acceptable
Critical
Very critical

Positive ecological assessment for FOAMGLAS®: Source: Cellular glass insulation, a cost-effective and environmentally sustainable solution. [Schaumglas-Dämmstoff, Wirtschaftlich und umweltverträglich Dämmen.] Markus Welter, Lucerne, Switzerland

Waste disposal

In the assessment of insulation materials one consideration is repercussions on the environment from waste disposal. There are significant differences between the various insulation products. In total evaluation – and considering the scarcity of raw materials – as documented in eco-balance data sheets for the building industry, plastic foam insulation receives poor ratings for environmental pollution.

Recycling

Cellular glass being non-combustible, combustion in a waste incineration plant is not possible. An option is the recycling of cellular glass as crushed stone (for bedding in road construction) or infill material for noise barriers. Recycled FOAMGLAS® is a safe and suitable product for these applications, as it is dimensionally stable, neutral for the environment, inorganic, rot-proof and without any risks for the ground water (meets ELUAT-test requirements). If crushed and recycled and not used as bedding or infill material, FOAMGLAS® can be taken to an inert waste disposal site, like crushed concrete or brick.

LEED® and FOAMGLAS® insulation

LEED® is an internationally recognized green building certification system, providing third-party verification that a

FOAMGLAS® – a valuable contribution to the protection of the environment.

- Today FOAMGLAS® is made from about 60 % recycled glass. The FOAMGLAS® manufacturing concept is waste reduction and green energy utilisation.
- In the FOAMGLAS® production only energy from renewable sources is used.
- Environmental pollution during manufacturing has halved when compared to 1995.
- FOAMGLAS® insulation meets all environmental and health requirements for construction products.
- At the end of its service-life FOAMGLAS® disposal is simple. One option is the use of recycled cellular glass as infill in trenches or back-up for buried pipes.
- FOAMGLAS® has an outstanding service-life, which is clearly the best for the environment.
- On balance: FOAMGLAS® is an insulation concept fit for the future that gives an answer to the genuine concerns for the environment. The system ensures that all demands on performance, durability, environmental integrity and sustainability are fulfilled.

- 3 The percentage of recycling glass in the FOAMGLAS® production has gone up from 30 to 60 %.
- 4 Crushed FOAMGLAS® – a recycled filler material for trenches.
- 5 FOAMGLAS® Environmental Product Declaration (according to ISO 14025).
- 6 FOAMGLAS® is Masdar A rating.

building or community was designed and built using strategies aimed at improving performance across all the metrics that matter most: energy savings, water efficiency, CO₂ emissions reduction, improved indoor environmental quality, and stewardship of resources and sensitivity to their impacts. FOAMGLAS® insulation

can contribute toward earning LEED® points on a project. While no one product or material alone can earn LEED® credit points, FOAMGLAS® can be used as part of a strategy to earn points in several credit categories. FOAMGLAS® is also eligible for Living Building Challenge™ Projects because it contains no red-listed materials.

Sustainable Sites – Vegetated Roof

LEED-NC Credit 6 – stormwater management

LEED-NC Credit 7.1 – roof heat island effect

FOAMGLAS® insulation can be part of a vegetated roof design, which is one sustainable strategy that can be used to earn both of these Sustainable Sites credits.

Energy & Atmosphere – Energy Performance and Refrigerant Management

LEED-NC Prerequisite 2 – minimum energy performance

LEED-NC Credit 1 – optimize energy performance

In the LEED® rating system, up to 19 points can be awarded for improved energy efficiency. FOAMGLAS® insulation can be used as one strategy to help achieve the required energy performance and to further reduce the amount of energy consumed.

LEED-NC Credits 4.1 and 4.2 – recycled content

FOAMGLAS® insulation that incorporates recycled materials can be included in this calculation of the total recycled content in all building materials.

Materials & Resources – Recyclable, Recycled Content and Regional Material

LEED-NC Credits 2.1 and 2.2 – construction waste management

FOAMGLAS® insulation scrap waste can be recycled.

LEED-NC Credit 4 – enhanced refrigerant management

Indoor Environmental Quality – Low-Emitting Materials

LEED-NC Credit 4 – low-emitting materials

Though insulation is not considered in this section, using FOAMGLAS® insulation eliminates another potential source of VOCs in a building. Low-VOC sealants and adhesives sold by Pittsburgh Corning could be used as part of this strategy.

Pittsburgh Corning FOAMGLAS® is committed to conducting its business in an environmentally responsible manner that protects the public, its employees, and a country's natural resources. Therefore, Pittsburgh Corning's environmental practices are in compliance with all applicable environmental laws and regulations.

www.foamglas.com

FOAMGLAS® Building

Pittsburgh Corning Europe

Rep. Office Middle East
Arenco Tower, Media City
P.O. Box 213345
Dubai, U.A.E.
Phone + 971 4 434 7140
Fax + 971 4 432 7109
info@foamglas.ae
www.foamglas.ae

Pittsburgh Corning Europe NV

Headquarters Europe, Middle East and Africa (EMEA)

Albertkade 1, B-3980 Tessenderlo
www.foamglas.com



Copyright Oct 2013. The product information and technical details contained in this brochure are accurate, according to our research and technical programme, at the point of going to press. We reserve the right to make any changes to the construction or product range, which seem technically appropriate, in view of our high standards for product advancement and development. All up-to-date data can be found under the button products on our website:
www.foamglas.com

