

# Insulation system for Façades

[www.foamglas.com](http://www.foamglas.com)

**FOAMGLAS®**  
Building

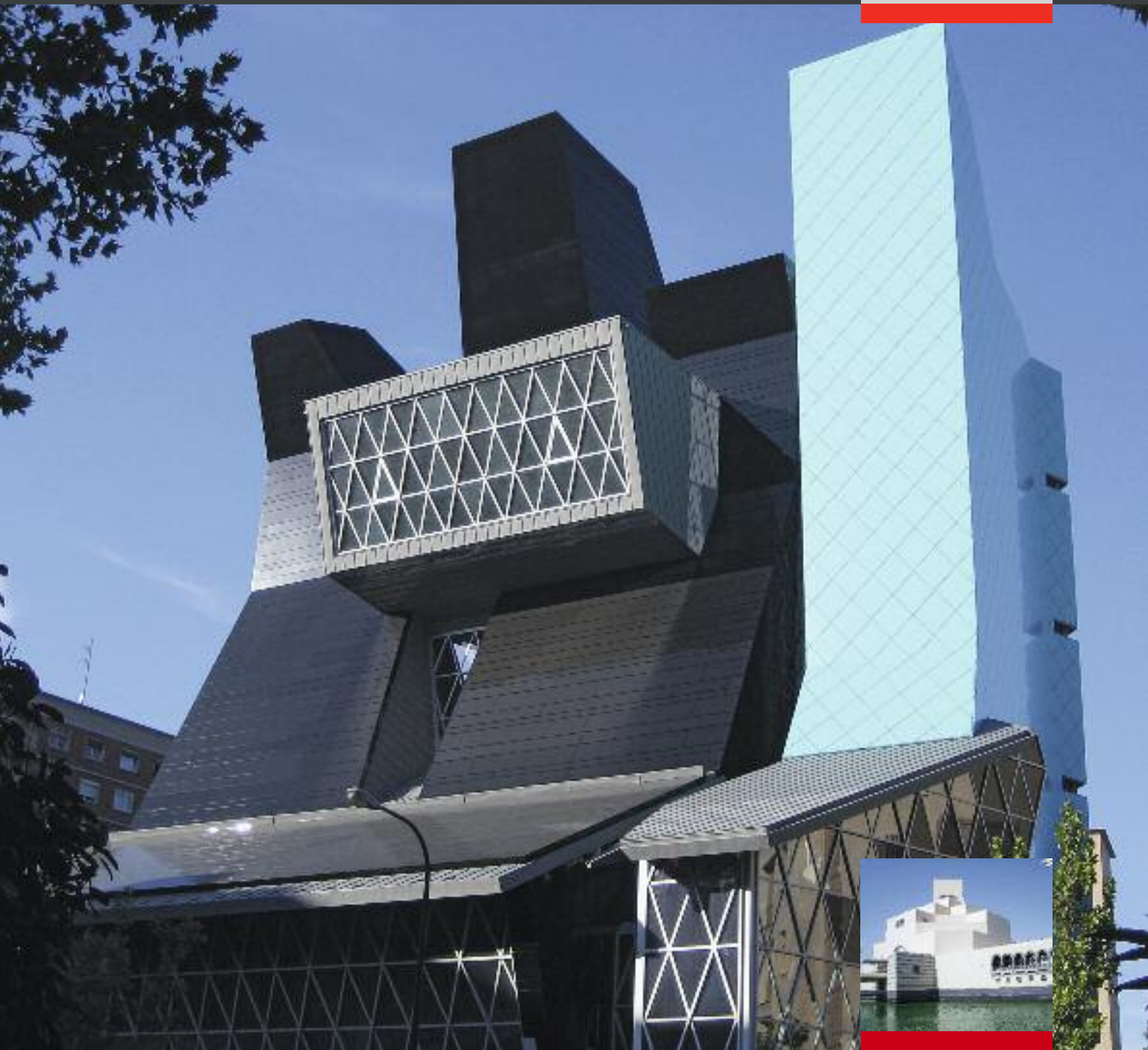

**FOAMGLAS®**

## Contents

<b>Aesthetics and protection</b>	<b>4</b>
<b>Warm façades</b>	<b>6</b>
<b>Ventilated rainscreen cladding</b>	<b>13</b>
<b>Cavity wall insulation</b>	<b>21</b>
<b>Building physics</b>	<b>24</b>
<b>Passive fire protection</b>	<b>30</b>
<b>Economy</b>	<b>33</b>
<b>Excellent ecological profile</b>	<b>35</b>



## Aesthetics and protection

The façade of any building is far more than its aesthetic “face” – it fulfils various functions, all of equal importance to the structure as a whole. Primarily it needs to protect the fabric of the building from the effects of weather – cold, heat and rain. It also plays a key part in sound proofing the building and providing fire protection. Thermal protection is, of course, the most essential performance. FOAMGLAS® ensures that all the demands made on an insulation material are fulfilled with a performance that remains totally effective for the lifetime of the building.

- 1 Warm façade on ground floor, Altersheim am Neumarkt, Winterthur
- 2 Cavity wall insulation, cantonal school “Luegeten”, Zug
- 3 Ventilated rainscreen cladding, Gurten Kulm – extension of the restaurant wing



**FOAMGLAS®**  
the ultimate insulation

FOAMGLAS® cellular glass insulation is unrivalled in performance whatever the building system. Cellular glass is foamed glass and constitutes of millions of closed, gas filled glass cells, which provide superior insulation characteristics. Due to the all glass cell geometry, the “vapour-control layer” is already built-in.

FOAMGLAS® is water- and vapour-proof, which means it is totally impervious to any form of moisture. Its high compressive strength makes the insulation resistant to compression – even under permanent loading. Other outstanding physical qualities of the glass material are: non-combustibility, dimensional stability (it cannot shrink or swell), it is rot-, insect-, vermin- and acid-proof (it will not support the growth of mould). FOAMGLAS® is environmentally sound (from manufacture to disposal) and is suited for all types of façade. The thermal insulation value remains as installed, for the lifetime of the building. The importance of the insulation and its performance cannot be overstated and is the key to an effective and financially efficient façade system.

**FOAMGLAS®**  
the ideal façade solution

Materials, structures, colours and shapes: Every type of imaginative façade can be combined with FOAMGLAS® insulation. The FOAMGLAS® solution enables architect’s schemes to be realised and adds to the structural stability of the whole cladding concept.

Independent of the wall- or cladding-system: Cellular glass insulation ensures exacting insulation values and the avoidance of cold bridging with a particularly thin façade structure. Nearly all façade materials are suited.

- **Warm façades: natural stone, clinker brick, metal, glass**
- **Ventilated façades (curtain wall): stone, timber, metal, glass, acrylic glass, fibre cement, wire mesh, trellis for greenery**
- **Cavity wall insulation: brick, lime-sand brick, exposed concrete**

**FOAMGLAS®**  
clear advantages

**For all demands:** Whatever the weathering and temperature conditions a building may be exposed to, FOAMGLAS® protects the building structure and optimises the energy needs for heating or air-conditioning.

**Cost-efficiency:** FOAMGLAS®-insulation systems convince the client for their durability. In many a façade rehabilitation the existent FOAMGLAS® insulation was found unchanged after 40 years of use and could be left in place.

**Safety:** FOAMGLAS® proves to be the “safety insulation”. This also means “fire safety”. Cellular glass insulation is classified as non-combustible to Euro Class A1 – no contribution to fire.

**Ecology:** FOAMGLAS® is ecologically sound and has no environmental health hazards. Due to its outstanding service life and overall environmental sustainability, FOAMGLAS® cellular glass is best-rated in comparative analysis of environmental product declaration.

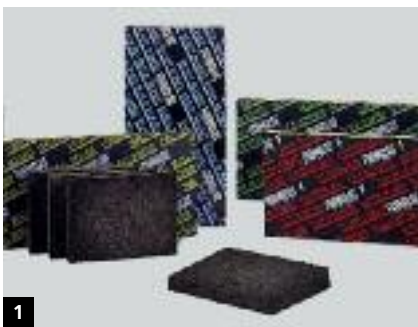

- 1 FOAMGLAS® Boards and slabs.
- 2 For every type of imaginative façade, Art Museum 'Kunsthaus Graz' (Austria).
- 3 Durability is the key to cost-efficiency, office building in Zurich.
- 4 Protection against heat and cold, Glacier 3000 cable car station.
- 5 Optimal energy efficiency, house designed to Swiss Minergy Standard, Mollis.





## Ventilated Facade

### Intercontinental & Crown Plaza Hotel, Festival City, Dubai

**Client** Al-Futtaim Group

**Architect** Cox Crone Architects

**Construction** 2003–2007

**Application** of FOAMGLAS® behind stone cladding facade 8000 m<sup>2</sup>

The Intercontinental and Crown Plaza Hotel are part of Festival City project which will be once finished one of the largest mixed-used development in Dubai. FOAMGLAS® is used behind the stone cladding because of the unique property of fully resistant to any kind of water and vapour and therefore can be applied on the wall structure without any additional protection against the high humidity. No additional foil for vapour protection is required through the closed cell structure of the material FOAMGLAS® itself. Result is the life time constant performance of the thermal insulation. Degradation through humidity abortion is the biggest problem in the Middle East for wall insulation next to fire issues. FOAMGLAS® is fully inorganic and will not support any fire. With no flame spread and no smoke development it provides specially in hotel project with towers the highest safety and ensures even in the building envelope the highest standard.

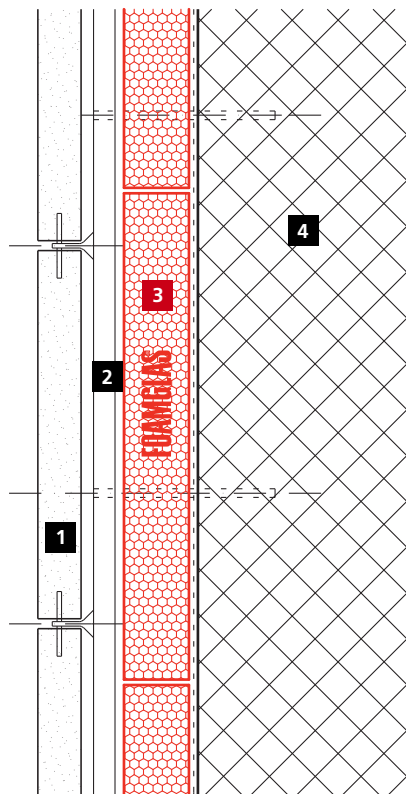

**Long term investment in safety and durability**

[www.foamglas.com](http://www.foamglas.com)

#### Build-up

- 1 Stone cladding
- 2 Rail support system for cladding fixed in concrete
- 3 FOAMGLAS® mechanically fixed
- 4 Structural wall concrete





## Warm façade

### Apartment house Steinhofstrasse, Lucerne

**Architect** Rüssli Architekten AG, Lucerne

**Construction** 2002

**FOAMGLAS® application** Façade insulation, about 175 m<sup>2</sup>, T4+ slabs, 120 mm thick, adhesively bonded

**Façade cladding** Folded metal cladding, warm façade (without ventilation space), fasteners/cleats are fixed to PC fixing plates (or claw plates)

As FOAMGLAS® is vapour-tight folded metal cladding can be installed without the need for a ventilation space. The number of elements needed is minimised, expensive and complicated sub-constructions such as additional lathing, roof boarding as a bearing course for the standing seam and ventilation slots are not needed. This saves costs and the construction thickness is reduced to a minimum. Simplicity and gain on the interior volume make the FOAMGLAS® solution a most economic system.

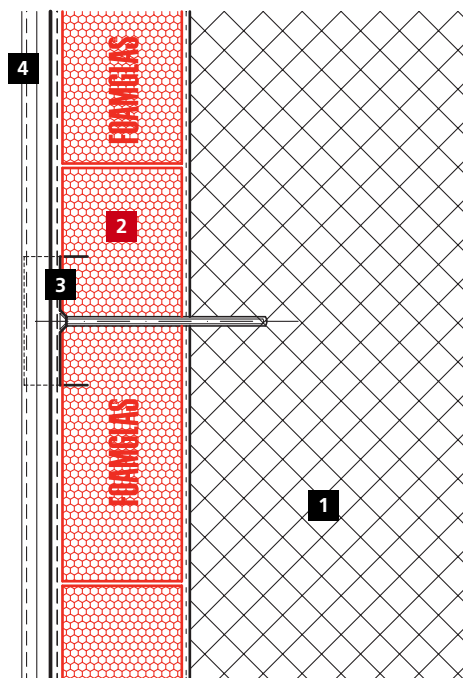

**Simplicity and economy due to reduced number of elements and gain of space**

[www.foamglas.com](http://www.foamglas.com)

#### Façade structure

- 1 Concrete load bearing structure
- 2 FOAMGLAS® T4+ insulation, adhesively bonded
- 3 PC fixing plates (claw plates) fixed to the structure and cleats for fixing the folded metal cladding
- 4 Folded metal cladding (standing seam sheets)





## Warm façade

### 'Schweizerhaus' building, Romanshorn

**Architect** D. Bötschi, Architekt ETH/SIA, Egnach

**Construction** 2003

**FOAMGLAS® application** Façade insulation, about 450 m<sup>2</sup>, T4+ slabs, 120 mm thick, adhesively bonded with surface coating applied to the insulation

**Façade cladding** Concrete slabs with sandstone finish, 50 mm thick, dimensions 800 x 600 and 800 x 200 mm, mechanically fixed with single structural fasteners

When façade claddings are inclined inwards they impose high demands on the thermal insulation applied to the structure. Water infiltration will occur and only the use of additional sealing methods or thermal insulation which is water-tight and totally resistant to moisture will protect the structure from becoming wet. FOAMGLAS® slab insulation – together with its surface coating – will prevent water inflow through the joints from reaching the structure. No membrane is required. Protection against heat loss and the effects of moisture is ensured in the long-term.

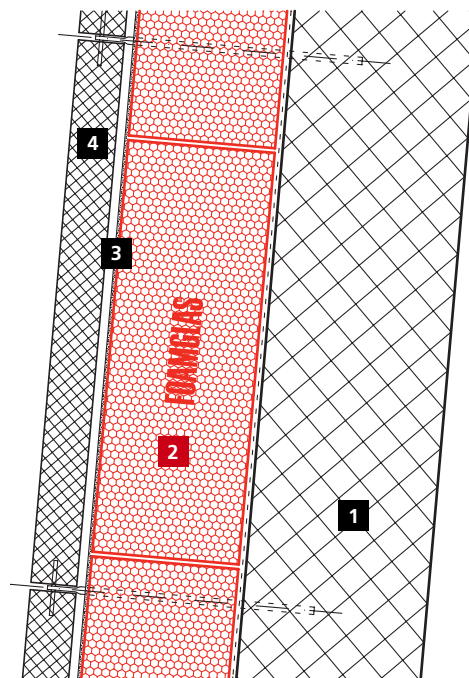

**Protection against cold and moisture in the long-term**

[www.foamglas.com](http://www.foamglas.com)

#### Façade structure

- 1 Concrete load bearing structure, inclination 5°
- 2 FOAMGLAS® T4+ insulation, adhesively bonded
- 3 Surface coating applied to the insulation
- 4 Prefabricated concrete slabs with sandstone finish, mechanically fixed through the insulation into the substructure







## Ventilated Rainscreen Cladding

### The Bachhaus Museum, Eisenach

**Architect** Penkhues Architekten, Kassel

**Construction** 2006

**FOAMGLAS® application** Behind stone cladding façade, mechanically fixed 620 m<sup>2</sup>, Type W+F, thickness 100 mm, adhered

**Cladding** Natural stone cladding

The Bachhaus Eisenach is the first museum in the world dedicated to Johann Sebastian Bach. It contains not only archive materials, household effects and bibliographic treasures from the times of Bach, but also a valuable collection of musical instruments as well as a specialty library.

To ensure lifetime performance of the façade it is not only the outer skin that needs to be high-end, but also the support structures and the thermal insulation layer in order to meet the quality demands. The FOAMGLAS® system provides high functional performance and is unaffected by driving rain and water vapour. It meets all the requirements of this type of high quality façade system and will perform for the lifetime of the building.

When façade claddings are inclined inwards, they impose high demands on the thermal insulation applied to the structure. FOAMGLAS® gives full security, as it does not sag or warp and cannot create any blockage of the rear

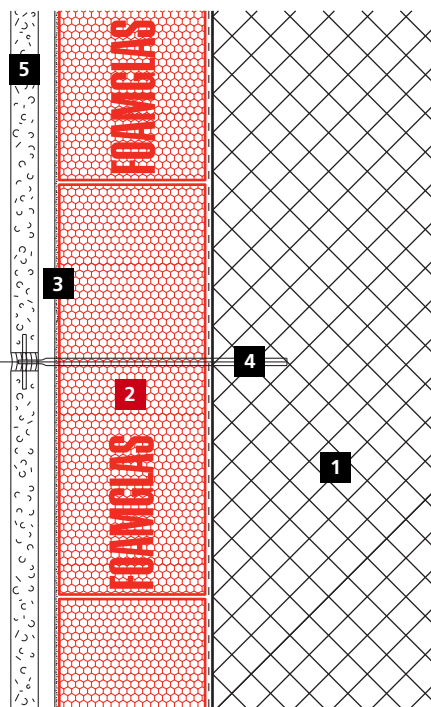

ventilation space. FOAMGLAS® provides heat and moisture protection in any position. The design possibilities are limitless.

Constant thermal value and outstanding service life using top-quality materials  
[www.foamglas.com](http://www.foamglas.com)

#### Build-up

- 1 Substrate
- 2 FOAMGLAS® W+F, adhered with PC® 164
- 3 Coating Pittcote® 404 with reinforcing mesh PC® FABRIC 79P
- 4 Anchors
- 5 Natural stone cladding





## Ventilated rainscreen cladding

### Museum of Islamic Art, Doha-Qatar

**Architect** I.M. Pei

**Construction** 2007

**FOAMGLAS® application** behind stone cladding facade mechanically fixed.

Total area of FOAMGLAS® applied for facade and flat roof 22 000 m<sup>2</sup>

The Museum of Islamic Art is situated on the southern part of Doha's seafont on a manmade island about 60 meters off the coast of Doha. The external wall of the Museum is finished with 6,500 M3 of natural stone work. High temperature combined with high humidity and an open joint application of the facade was asking for a high quality of the structure below, specially the thermal protection because access to the ventilation space is not provided any more. The FOAMGLAS® cellular glass insulation with the closed cell structure guarantees a life term solution because it can never absorb any humidity neither from humid air nor from rain or condensation. The lifelong constant performance is ensured and any upgrading of HVC equipment never required.

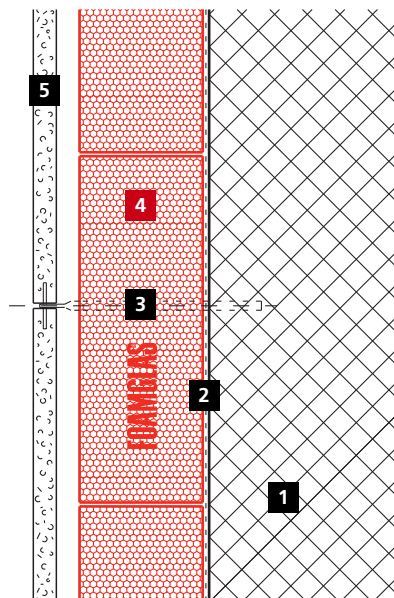

**Stable value and out-standing service life using top-quality materials**  
[www.foamglas.com](http://www.foamglas.com)

#### Facade structure

- 1 Solid wall (concrete/brickwork)
- 2 Primer coat
- 3 Resin anchor
- 4 FOAMGLAS® slabs, bonded with PC® 56
- 5 Large format stone slab cladding





## Ventilated Rainscreen Cladding

### Auditorium Beiersdorf AG, Forschungszentrum III, Hamburg

**Architect** HHS AG, Kassel

**Engineer's Office** Eurolabor, Kassel

**Construction** 2003

**FOAMGLAS® application** Exterior insulation, Type READY BLOCK, thickness 100 mm, adhered

**Cladding** Stainless steel shingles, battens and counter battens fixed to substrate

Beiersdorf AG has its research and development centre in Hamburg-Eimsbüttel. They centralise the core activities of cosmetic research and development in different sections, laboratories and office buildings. An auditorium with a capacity for 500 people has been added as an extension. With its contrasting organic shape it forms a visual contrast in the green courtyard, surrounded by geometric buildings.

A range of materials such as brick, glass, metal and fair-faced concrete is used for the "skin" of the old and new buildings, linked by a bridge.

FOAMGLAS® is non-combustible and unaffected by water or water vapour. FOAMGLAS® eliminates the potential of any damage to the wall system or insulation itself from rodents, insects, birds, etc. as it provides no source of food for nesting animals.

**A long-term effective construction saves costs**

[www.foamglas.com](http://www.foamglas.com)

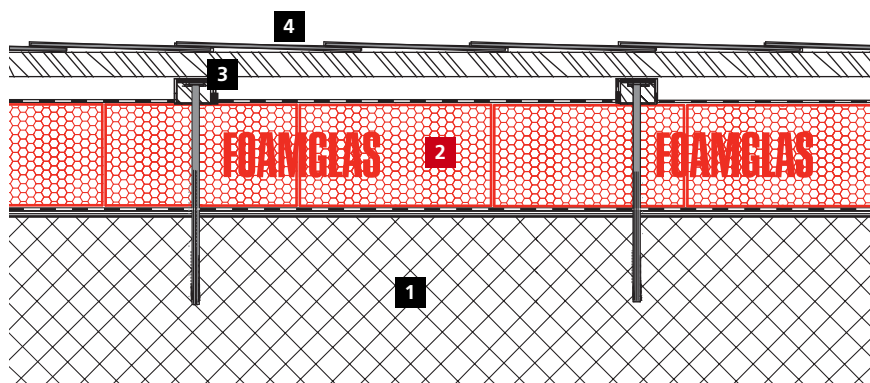

#### Build-up

- 1 Substrate
- 2 FOAMGLAS® READY BLOCK, adhered with PC®SK-Fix
- 3 Battens and counter battens (aluminium)
- 4 Stainless steel shingles





## Ventilated rainscreen cladding

### The IAACC Pablo Serrano Museum, Saragossa, Spain

**Owner** The Culture Department of Zaragoza

**Architect** José Manuel Pérez Latorre

**Built** 2010

**Constructor** Nexometal

**Thermal insulation** 7000 m<sup>2</sup> FOAMGLAS® READY BLOCK 60 mm

**Finish** Composite Panel

Having extended and renovated its existing building, the IAACC (Instituto Aragonés de Arte y Cultura Contemporáneos) Pablo Serrano re-opens its doors and is set to become a benchmark for contemporary culture not just in the Aragon region but on a national and international level. The newly opened museum aims to provide deepening knowledge of the Aragonese sculptor from whom it gets its name. The Pablo Serrano Museum is located in the old workshops of the Provincial Orphanage, which were refurbished by the architect José Manuel Pérez Latorre, to suit the new role as museum. The interior includes the work of Pablo Serrano combined with temporary exhibitions of contemporary painting and sculpture. The space of the new building is amazing, with its volume increased from 2 500 m<sup>2</sup> to 7 500 m<sup>2</sup>, it is furthermore enhanced by an unusual fenced area incorporating an external light enclosure which is painted in a special colour that looks like “a precious stone reflecting the sky”. FOAMGLAS® has been chosen

because it could ensure dimensional stability and unaltered performance throughout the entire service life of the building.

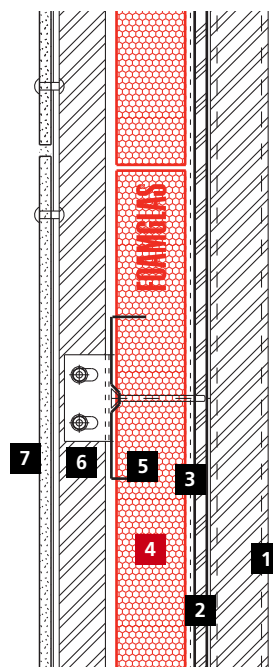

**Safety and aesthetics – a new system becomes the thing**

[www.foamglas.com](http://www.foamglas.com)

#### Build-up

- 1 Steel Structure
- 2 Timber pannel
- 3 Primer
- 4 FOAMGLAS® READY BLOCKS (60 mm) glued in full adherence
- 5 Perforated metal Plates PC® SP 150 x 150 mm (fixed through the trimber pannel)
- 6 L aluminium profiles (fixed inside the metal plates)
- 7 Composite Panels





## Ventilated Rainscreen Cladding

### Museum, Didymoteichon, Thrace/N. Greece

**Owner** Hellenic Ministry of Culture

**Architects** MEAS S.A., P. Petrakopoulos, E. Digonis & Associates, Athens

**Construction** 2008

**FOAMGLAS® application** Underground walls; external wall insulation under heavy cladding, 562 m<sup>2</sup>, type T4+ slabs, 40 mm thick; concrete roof insulation, 752 m<sup>2</sup>, type T4+ slabs, 50 mm thick; angle fillets 648 lm

**Wall finish** Heavy cladding

The region of Didymoteichon has presented findings since the Neolithic age. The city itself was important throughout the Hellenistic, Roman, Byzantine, Ottoman regimes and also throughout Modern Greek history. The construction of this new Museum aims to enhance local cultural life and bring to light the importance of the region throughout history.

FOAMGLAS® is applied to insulate roofs, walls and below-grade to protect the building and the exhibits from extreme temperatures as they are not unusual in the north of the country.

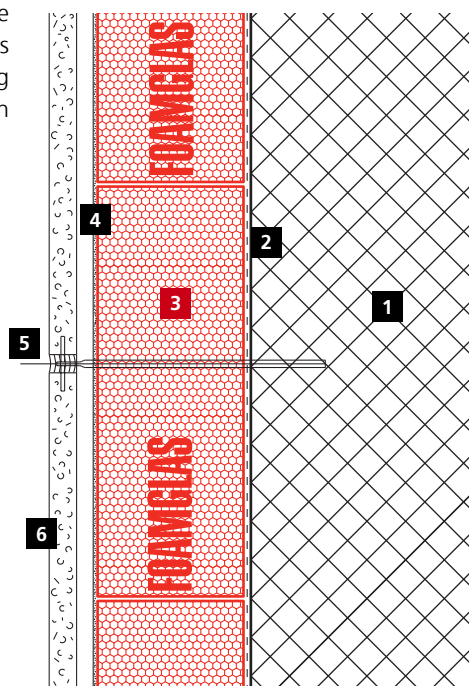

**FOAMGLAS® – to protect the construction and the exhibits**  
[www.foamglas.com](http://www.foamglas.com)

#### Wall structure

- 1 Structural concrete wall
- 2 Bitumen based primer
- 3 FOAMGLAS® T4+, 40 mm, adhesively bonded
- 4 Surface coating
- 5 Structural fixing to the concrete structure
- 6 Heavy cladding





## Ventilated rainscreen cladding

### Gurten Kulm restaurant destination, extension of dining hall, Berne

**Architect** Büro B, Architekten und Planer, Berne

**Retrofit works** 1999

**FOAMGLAS® application** Façade insulation, about 450 m<sup>2</sup>, T4+ slabs, 100 mm thick, adhesively bonded

**Façade cladding** Timber and aluminium slats, substructure timber or aluminium, visible fasteners for fixing the slats to the substructure

Timber and aluminium slats are often used to create the appearance and effect of cladding; they have open joints and are carried on a substructure of timber or aluminium, allowing ingress of moisture. The use of FOAMGLAS® insulation allows for large spacing between the slats and ensures that rainwater inflow through the open joints of the cladding will not affect the insulation performance and lead to its deterioration. The insulation is finished with a surface filler. The wall construction will remain dry ensuring that insulation values are maintained. Technical and aesthetic design requirements are met.

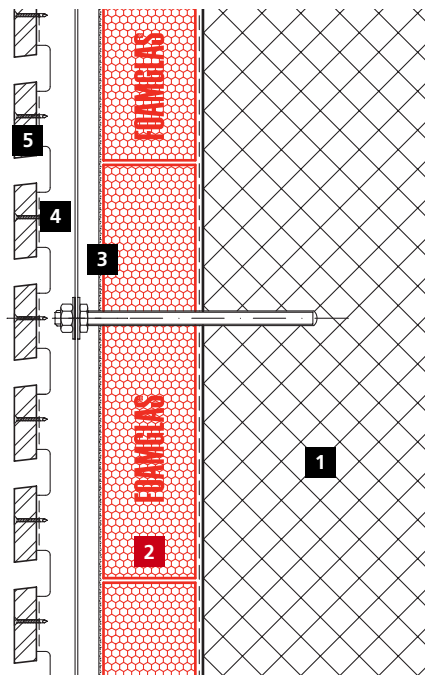

**Stylish appearance and long-term performance**

[www.foamglas.com](http://www.foamglas.com)

#### Façade structure

- 1 Concrete load bearing structure
- 2 FOAMGLAS® T4+ insulation, adhesively bonded
- 3 Surface filler finish
- 4 Metal substructure
- 5 Timber cladding





## Ventilated rainscreen cladding

### Casa Travella, Castel S. Pietro

**Architect** Celoria Aldo, Morbio Inferiore

**Construction** 2003

**FOAMGLAS® application** Façade insulation, about 150 m<sup>2</sup>,  
FOAMGLAS® WALL BOARD, 80 mm thick, adhesively bonded

**Façade cladding** Copper shingle cladding

Casa Travella's outstanding landmark is the upper floor façade with copper shingle cladding. Copper shingles do not only emphasise the unique appearance of the building, they also stand for all-weather performance and long service life. In combination with FOAMGLAS® insulation, which performs for the lifetime of the building, a durable, value-preserving façade architecture is provided. In case of rainwater inflow through the seams, the construction will not be affected. Cellular glass insulation forms an effective barrier against water ingress and water vapour.

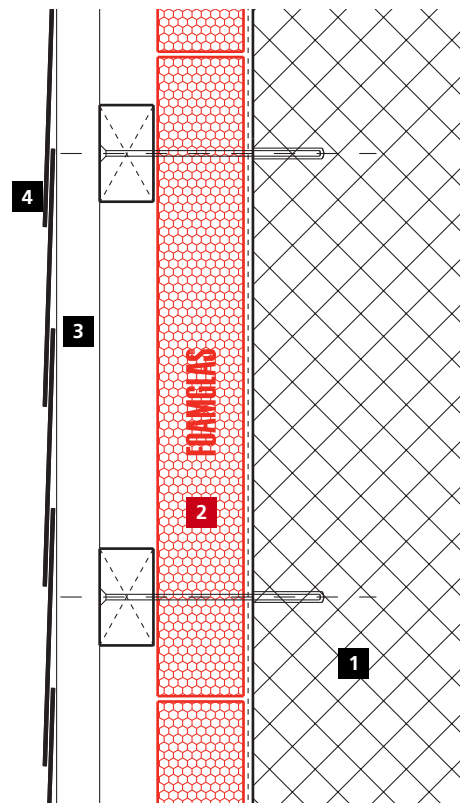

**FOAMGLAS® – all weather insulation**  
[www.foamglas.com](http://www.foamglas.com)

#### Façade structure

- 1 Concrete load bearing structure
- 2 FOAMGLAS® WALL BOARD insulation, 80 mm thick, adhesively bonded
- 3 Support lathing, cross lathing
- 4 Copper shingle cladding





## Ventilated rainscreen cladding

### Schwyzer Kantonalbank, Pfäffikon

**Architect** Halter Architekten AG, Rapperswil

**Construction** 2003

**FOAMGLAS® application** Façade insulation, about 600 m<sup>2</sup>, T4+ slabs, 160 mm thick, adhesively bonded, and paint finish

**Façade cladding** ESG glass cladding, 10 mm thick, with silk-screen printing – discharge print imitation, metal substructure fixed to a structurally fixed supporting plate, glass cladding with visible fixing points

Glass façades impose extreme loads on the substructure and in particular on the thermal insulation behind it. Due to retained heat, extremely high temperatures are created and these can rapidly drop when rain occurs. As a consequence condensation can form in the façade structure. FOAMGLAS® insulation is impervious to water and water vapour and will not allow deterioration from condensation. It has dimensional stability and resistance to expansion or swelling even under severe temperature fluctuations and moisture conditions.

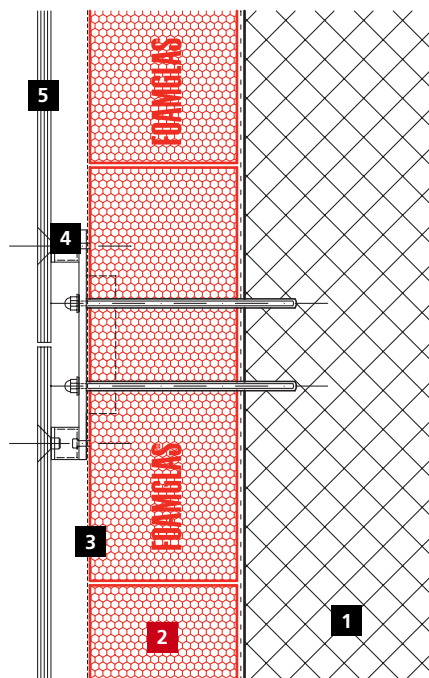

**Dimensional stability and resistance to expansion or swelling under temperature fluctuations and moisture conditions**  
[www.foamglas.com](http://www.foamglas.com)

#### Façade structure

- 1 Concrete structure
- 2 FOAMGLAS® T4+ insulation, adhesively bonded
- 3 Paint finish
- 4 Supporting plate, mechanically fixed to the structure
- 5 Glass cladding







## Ventilated rainscreen cladding

### Art museum Kunsthaus Graz ("Bubble", "Blue Bubble"), Graz (Austria)

**Architect** Peter Cook + Colin Fournier, London

**Construction** 2002/2003

**FOAMGLAS® application** Roof and façade insulation, special shaped roof, about 3670 m<sup>2</sup>, T4+ slabs, 160 mm thick, adhesively bonded, mechanically fixed in parts

**Façade cladding** Tinted and open-jointed acrylic panels, visible fixing points on the cladding elements

This special shaped building is a most demanding construction with a complex structure. On this imaginative structure, the external panels are of aesthetic value only; the open joints provide no protection against driving rain or environmental conditions. The layers beneath the panels must fulfil the function of both weather-tightness and insulation of the building. FOAMGLAS® applied below the membrane effectively meets both these demands and the clamping system ensures the minimum of cold bridging in the wall and roof constructions. Independent of the type and shape of load-bearing structure – concrete or steel deck, flat or curved – cellular glass insulation is easily cut to shape and will perfectly adhere, with a maximum

of contact surface, to the structural wall/roof. Proud edges on the insulation can easily be smoothed with a grinding tool. With FOAMGLAS® insulation all design options are possible.

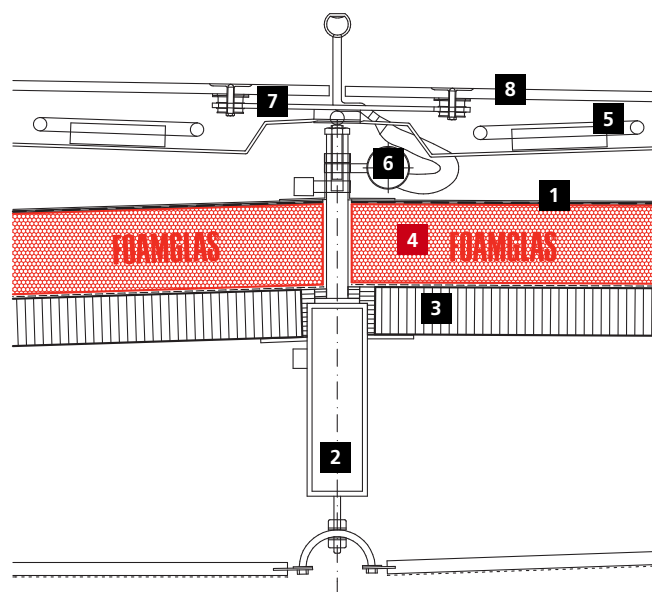

**Imaginative structure – weathertight system**  
[www.foamglas.com](http://www.foamglas.com)

#### Façade structure

- 1 Synthetic membrane (bitumen compatible waterproofing sheet)
- 2 Supporting framework, primary steel truss
- 3 Steel decking
- 4 FOAMGLAS® T4+ insulation, 160 mm thick
- 5 Under-façade BIX lightning
- 6 Sprinkler nozzle
- 7 Support for panels
- 8 Open-jointed acrylic panels





## Ventilated rainscreen cladding

### Cheese factory Windleten, Ennetmoos

**Architect** Architekturbüro R. Niederberger, Hergiswil

**Construction** 1995

**FOAMGLAS® application** Façade insulation, about 700 m<sup>2</sup> of FOAMGLAS® WALL BOARD, 100 mm thick, adhesively bonded

**Façade cladding** Eternit cladding – small size fibre cement tiles, timber sub-construction support lathing/cross lathing, secret-fixing of the cladding tiles

FOAMGLAS® is non-combustible and unaffected by water or water vapour. An added advantage for cladding and rainscreen systems with ventilation is, that totally inorganic cellular glass is vermin and mould proof. No damage is caused to the insulation or system by rodents, insects, birds, etc, as FOAMGLAS® provides no source of food or nesting material. This means that all underground structures can also be insulated without any risks of damage.

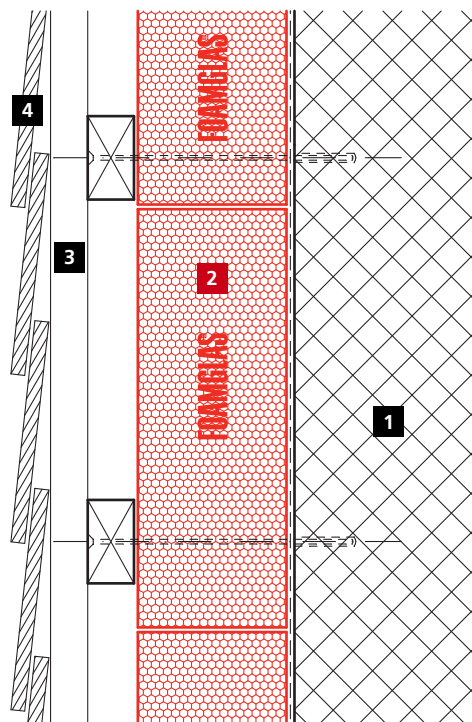

**Best protection against rodents, insects and mould**  
[www.foamglas.com](http://www.foamglas.com)

#### Façade structure

- 1 Concrete structure
- 2 FOAMGLAS® WALL BOARD insulation, adhesively bonded
- 3 Timber support structure (lathing and cross-lathing)
- 4 Eternit cladding – fibre cement tiles





## Ventilated rainscreen cladding

### Seewasserwerk (Water supply works), Männedorf

**Architect** Theo Hotz AG, Zurich

**Construction** 2005

**FOAMGLAS® application** Façade insulation, about 630 m<sup>2</sup>, T4+ slabs, 100 mm thick, adhesively bonded

**Façade cladding** Wire mesh

See-through wire mesh as the external skin is of aesthetic value only; it does not provide protection against driving rain or environmental conditions. The layers beneath the wire mesh must fulfil the function of both weather-tightness and insulation of the building. FOAMGLAS® insulation with sur-

face filler finish does not require additional waterproofing sheets. The coated FOAMGLAS® system is resistant against any weathering conditions, including UV resistance, and moreover meets the surface design requirements behind open wire mesh.

**Longterm protection against moisture**

[www.foamglas.com](http://www.foamglas.com)

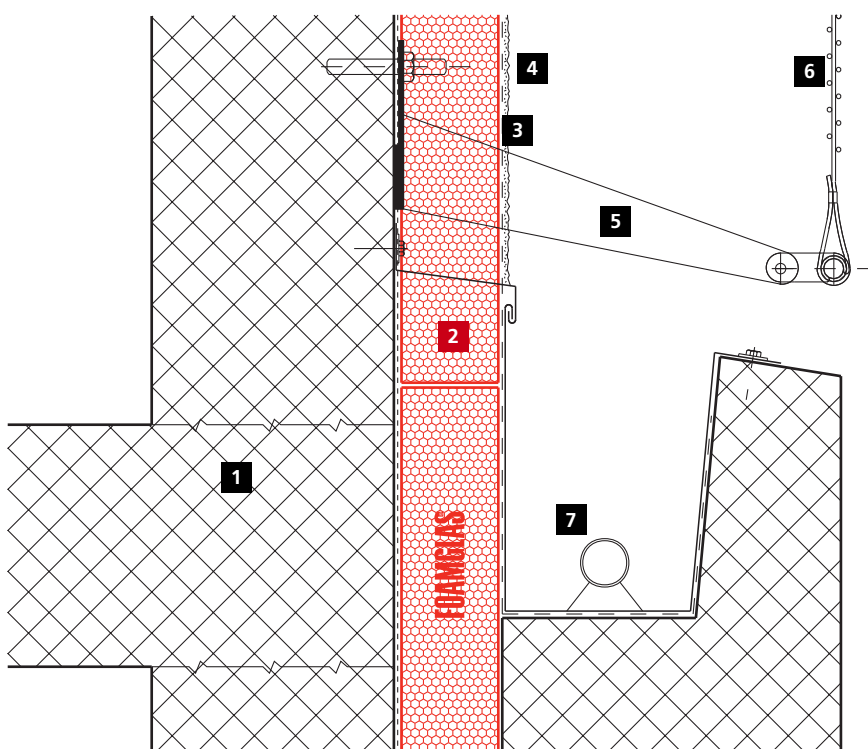

#### Façade structure

- 1 Concrete structure
- 2 FOAMGLAS® T4+ insulation, adhesively bonded
- 3 Surface filler coating with reinforcement fabric
- 4 Special render coat
- 5 Clamping device
- 6 Wire mesh
- 7 Lightning





## Ventilated rainscreen cladding

### Traffic flow management and traffic information centre Asfinag, Wien-Inzersdorf

**Architect** Arch. Prof. Adolf Krischanitz, DI Viktoria von Gaudecker

**Construction** 2004

**FOAMGLAS® application** Façade and projecting floor insulation, 600 m<sup>2</sup>, T4+ slabs, 8 cm thick, adhesively bonded

**Finishing work** Façade greening with trellis as growth support

Due to its closed cell structure FOAMGLAS® cellular glass has excellent thermal insulation values. The all glass insulation creates an efficient barrier against moisture. It is fully root proof and therefore perfectly suited for façade greening systems. A visually neutral surface coating is directly applied to the FOAMGLAS® insulation, which brings the plantings into focus. FOAMGLAS® provides durable protection against weathering and root penetration.

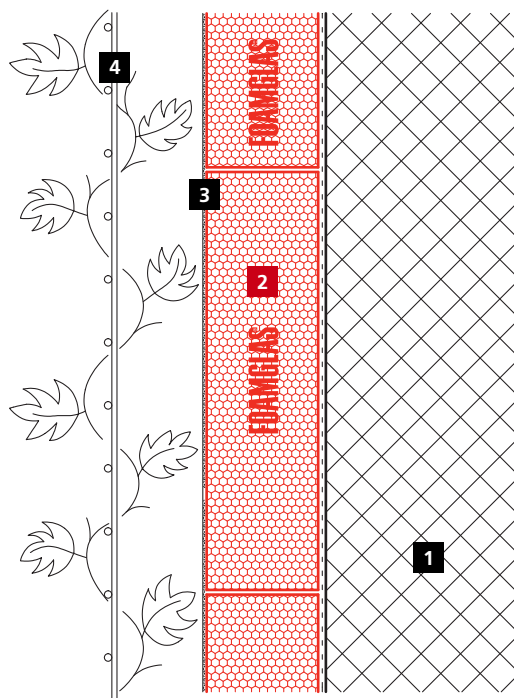

**Façade greening without side effects**  
[www.foamglas.com](http://www.foamglas.com)

#### Façade structure

- 1 Concrete structure
- 2 FOAMGLAS® T4+ insulation, adhesively bonded
- 3 Surface filler coating with reinforcement fabric
- 4 Trellis and climbing plants





## Cavity wall insulation

### Resurrection Cathedral, Evry (France)

**Architect** Mario Botta, Lugano

**Construction** 1989–95

**FOAMGLAS® application** Cavity wall insulation, about 2700 m<sup>2</sup>, type Wall Board, 80 mm thick, mechanically fixed

**External wall** Claybrick from Toulouse, wall ties in stainless steel

During construction, the inner skin is installed first followed by the insulation, which often means that conventional insulation materials – susceptible to the uptake of moisture – are wet before the outer skin can be installed. Not so with FOAMGLAS®, which is an all-weather insulation and ensures dimensional stability and unaltered performance throughout the entire service life of the wall construction.

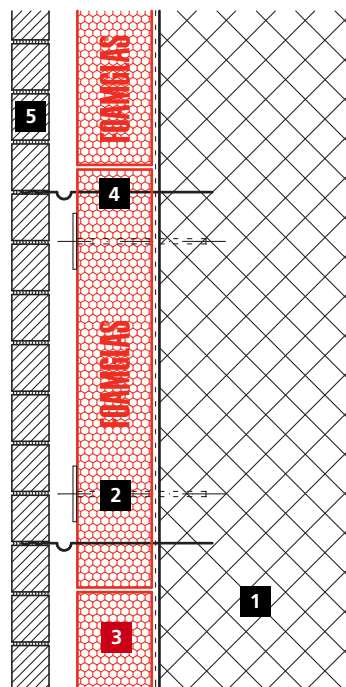

## Weather-tight during construction

[www.foamglas.com](http://www.foamglas.com)

### Façade structure

- 1 Structural concrete wall, inner skin
- 2 Wall tie
- 3 FOAMGLAS® WALL BOARD insulation
- 4 Mechanical fastening
- 5 External wall, outer skin





## Cavity wall insulation

### Texas A&M University Doha-Qatar

**Architect** Halcrow

**Construction** 2005–2007

**Application of FOAMGLAS®** in cavity wall

Texas A&M at Qatar is part of Education City, home to branch campuses of some of America's best universities and academic programs. The university offers undergraduate degrees in chemical, electrical, mechanical, and petroleum engineering. A two layer brick wall does not provide a fully water and vapour proof external shell and high humidity and extreme heat can affect the thermal insulation between. With the use FOAMGLAS® a material is used which will never warp, sack or lose any of the performance over the whole lifecycle of the building. FOAMGLAS® will remain dry and provides constant performance, is fully inorganic and will not support any fire. No flame spread and no smoke development.

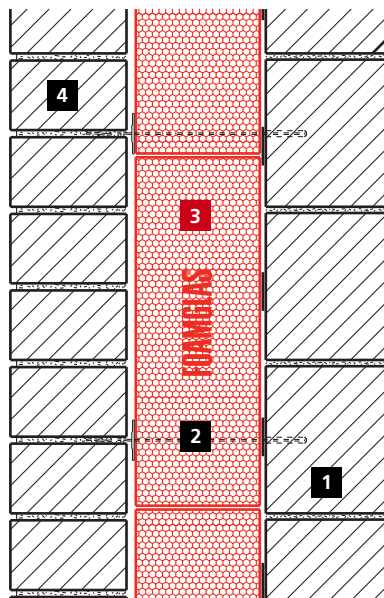

**Risk reduction for non-accessible structural components**  
[www.foamglas.com](http://www.foamglas.com)

#### Build-up

- 1 Interior wall (brickwork/ concrete)
- 2 Wall tie
- 3 FOAMGLAS® WALL BOARD, bonded with PC® 56
- 4 Outer wall (brickwork)





## Cavity wall insulation

### Cantonal school, Zug

**Architect** Enzmann + Fischer AG, ArchitektInnen BSA/SIA, Zurich

**Construction** 2003

**FOAMGLAS® application** Cavity wall insulation, about 2140 m<sup>2</sup>, T4+ slabs, 40/200 mm thick, adhesively bonded

**Outer shell** Cast-in-place concrete (exposed concrete)

Twin-skin concrete constructions make high demands on the insulation material. The insulation layer is unapproachable later and has to be particularly robust to face a number of risks which include: the effects of high loading and moisture when the concreting for the outer shell is done as well as possible water infiltration through cracks and damaged joints during and after con-

struction. It is with good reason that FOAMGLAS® is called "safety insulation". Due to high compressive strength and imperviousness to moisture, it ensures that all the demands made on the insulation material are fulfilled with a performance that remains totally effective for the lifetime of the building.

**Risk reduction for non-accessible structural components**  
[www.foamglas.com](http://www.foamglas.com)

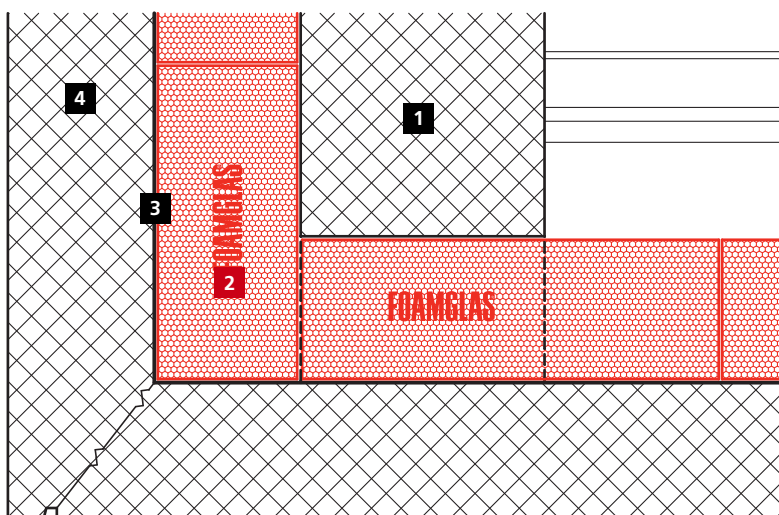

#### Façade structure

- 1 Structural wall, first floor
- 2 FOAMGLAS® T4+ slabs, adhesively bonded
- 3 Surface filler coating
- 4 Outer shell, exposed concrete





1 Cable car station  
Glacier 3000,  
Waadtländer Alps (CH)

## The ideal solution in terms of building physics

The thermal and physical demands on the external walls of a building are extremely high and conditioned by the environment, the structural design and the use of the building. Different physical interactions occur and various functions have to be fulfilled, all of equal importance to the structure as a whole. What are the weathering, the temperature and the nuisance conditions for the building? How do we achieve a comfortable indoor climate for the occupants without undesirable effects? Whatever the conditions are, FOAMGLAS® provides an optimal solution.

### Considerations regarding the quality and durability of buildings

Traditional fields of building physics are thermal insulation, protection against moisture, sound proofing and fire safety. The elimination of undesirable physical interactions is most important for the quality of the building and healthy living conditions. Determinants are – in addition to economic issues – system performance, service life, indoor climate, energy efficiency and environmental impact. The

target of building physics is to improve the living conditions for the occupants and to protect the building against undesirable effects. At that thermal insulation plays a key part.

Particularly with regard to the growing interest in low-energy houses, thermal insulation and energy-saving technology is of primary importance. Thicker insulation on all enclosure surfaces is certainly an important step to be taken, however the wall structure has to be designed and fitted accordingly, in particular at door and window openings.

Inadequate thermal insulation should not be underestimated, as it may not only cause heat loss but constitute a serious risk for the building's structure itself. Well designed thermal insulation significantly saves energy costs and provides protection against damage on the building.

### Avoidance of cold bridging

Ventilated rainscreen cladding systems appear to be a safe solution in view of building physics. With the right choice of materials and design, the rainscreen cladding can efficiently provide protection from the effects of weather in the



long term and enable the most imaginative scheme to be realised. As a rule, cold bridging should be avoided. These weak points are created where mechanical fasteners for the suspension of the rainscreen cladding have through-fix anchoring which generate additional energy loss.

A number of studies – for example by EMPA Dübendorf (Swiss Material Testing Institute) – have been made to evaluate the heat loss that occurs in many wall constructions because of the

increasing not only in Switzerland, but Europe wide. It is absolute necessity to develop new, innovative and energy-efficient solutions. The Swiss 'Bundesamt für Energie' (BFE, Federal Office for Energy) and 'Fachhochschule Nordwestschweiz/beider Basel' (FHNW/ FHBB, University of Applied Sciences Northwestern Switzerland) took the initiative and invited the industry to an idea contest. In the beginning of 2000 ten teams were selected to develop the subject "Thermally optimised structural sup-

port elements for ventilated rainscreen cladding systems". The FOAMGLAS®-plus works with the following components:

- The self-supporting insulation in high-compressive strength FOAMGLAS® is adhesively bonded to the load bearing wall and forms a totally integrated surface, without effects of heat losses and air leaks. (Joints are closed and water-tight, additional support for the insulation is provided at window/door lintels and at the base of the wall by use of angle bars).

- Metal fixing plates (U-shaped claw plates in galvanized steel) are pressed on to the FOAMGLAS® surface, adhesively bonded and mechanically fixed to the structure. The fixing level for the ventilated rainscreen cladding is placed on the upper side of the insulation, an installation method, which creates minimal cold bridging.

- Metal fixing plates (claw plates) and bolt/screw connection to the main structure allow for a safe mounting of conventional façade support structures (in timber, metal) to bear the cladding elements. The system is designed for lightweight to medium-heavy cladding elements of small, medium or large size.



structural support element for the cladding passes through the thermal insulation and onto the load bearing structure. Measurements from field studies for different façade systems were compared to computational results from a three-dimensional program. As a result: The support and fixing method has a considerable influence on the overall insulation value of the rear ventilated façade. A high level of heat loss has been seen, about 13–80% dependent on the type of construction and the materials (see figures "Heat losses" on pages 26/27). This undesirable effect is maximized with growing insulation thickness – which obviously correlates with heavier structural fasteners.

For energy policy reasons, the trend towards thicker façade insulation is

port elements for ventilated rainscreen cladding systems". The FOAMGLAS®-team obtained the first prize with enterprise allowance for the new cladding support system FOAMGLAS®-plus.

### The FOAMGLAS®-plus system

This new concept for rainscreen cladding support reduces cold bridging and achieves best overall insulation values for ventilated façades. By use of high compressive strength FOAMGLAS® insulation adhesively bonded to the structural wall and placement of the metal fixing plate/claw plate – or T-console for heavier façade systems – to support the subconstruction/cladding in front of the insulation, a system is available

## Heat losses as percentage for different structural support elements

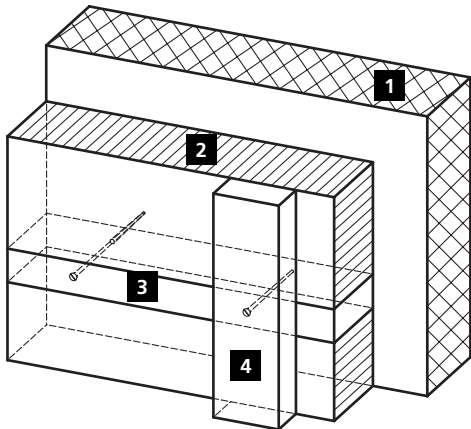

### Timber lathing<sup>1</sup>

- 1 Structural wall
- 2 Thermal insulation
- 3 Support lathing through the insulation
- 4 Façade support lathing

**+21%**

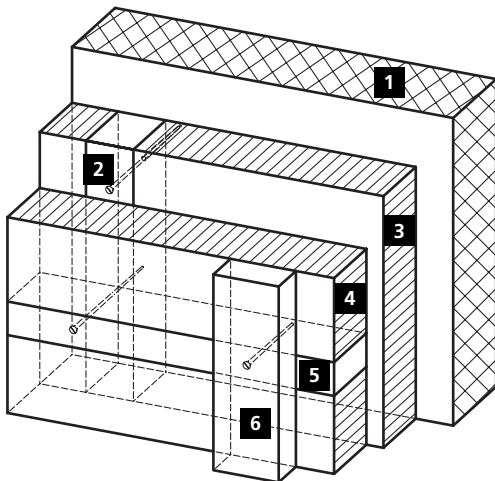

### Timber lathing, crosswise<sup>1</sup>

- 1 Structural wall
- 2 Support lathing through the insulation
- 3 Thermal insulation – layer 1
- 4 Thermal insulation – layer 2
- 5 Secondary lathing
- 4 Façade support lathing

**+13%**

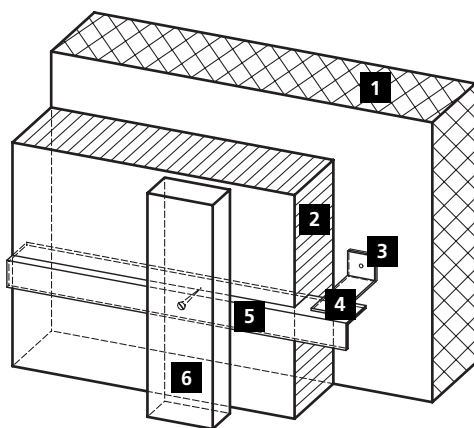

### Steel brackets and angle profiles<sup>1</sup>

- 1 Load bearing wall
- 2 Thermal insulation
- 3 Decoupled buffer
- 4 Fixing bracket
- 5 Façade load bearing metal profile
- 6 Support lathing

**+17%**

<sup>1</sup> Source (values and systems): Richtlinie "Bestimmung der wärmetechnischen Einflüsse von Wärmebrücken bei vorgehängten hinterlüfteten Fassaden", EMPA, Ausgabe 1998. (Code of practice "Heat losses as percentage due to cold bridging and air leaks", EMPA, edition 1998)

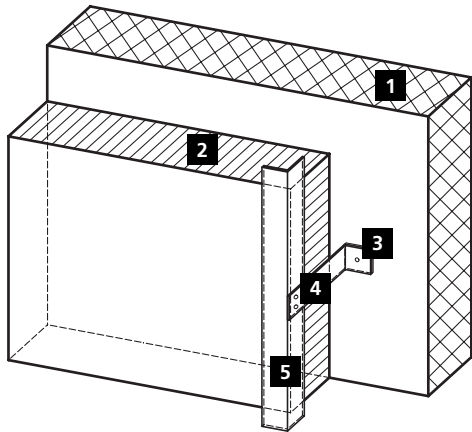

### Aluminium brackets and aluminium angle profiles<sup>1</sup>

- 1 Load bearing wall
- 2 Thermal insulation
- 3 Decoupled buffer
- 4 Fixing bracket
- 5 Aluminium steel support for the façade

**+ 28 %**

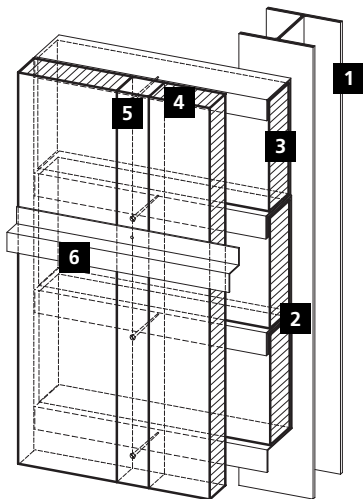

### Metal cassette wall and two layers of insulation<sup>2</sup>

- 1 Supporting steelwork
- 2 Metall cassette
- 3 Thermal insulation – layer 1
- 4 Thermal insulation – layer 2
- 5 Timber or metal support
- 6 Metal façade fixing profile

**+ 80 %**

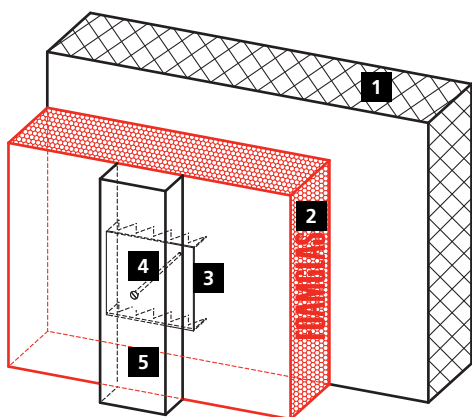

### FOAMGLAS®-plus façade<sup>3</sup>

- 1 Load bearing wall
- 2 FOAMGLAS® T4+ slabs
- 3 Metal fixing plates (claw plates)
- 4 Bolt/screw connection to the main structure
- 5 Metal/timber support structure for the façade

**+ 4 %**

- 1 Source (values and systems): Richtlinie "Bestimmung der wärmetechnischen Einflüsse von Wärmebrücken bei vorgehängten hinterlüfteten Fassaden", EMPA, Ausgabe 1998. (Code of practice "Heat losses as percentage due to cold bridging and air leaks", EMPA, edition 1998).
- 2 Source (values and systems): "EMPA-Schlussbericht F+E" Nr. 127378: Hinterlüfteten Fassaden. (EMPA final report Nr. 127378: Ventilated façades).
- 3 Source (values and systems): "Wärmebrücken aus kraftschlüssiger Verankerung von hinterlüfteten Fassaden-Bekleidungen", Weder+Bangerter AG, Ingenieure und Fachverlag, www.baudaten.com (Cold bridges from through-fix anchoring of rear ventilated façade systems).

## FOAMGLAS® insulation: unrivalled performance

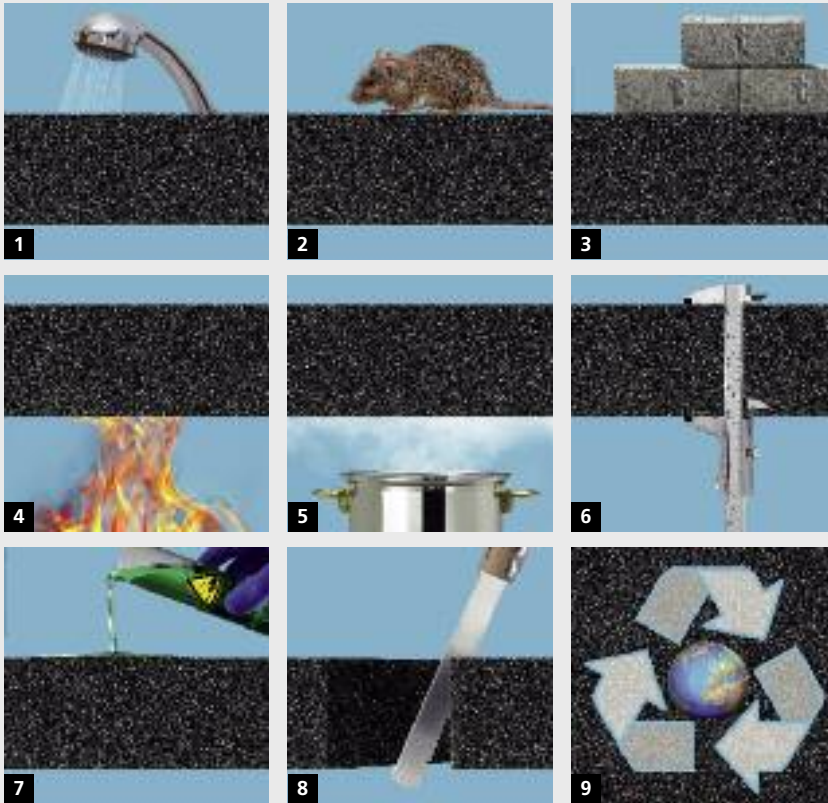

## Adhesively bonded facing elements/bricks on FOAMGLAS® insulation

By the thermally optimised mechanical fixing of the support structure for rainscreen cladding – due to the FOAMGLAS®-plus system – remarkable improvements on the overall insulation value of the ventilated façade can be achieved.

Absolutely best performance without heat losses – for a minimized thickness of the façade structure – can be achieved without any through fixings. A façade structure excluding all cold bridges is possible when the outer leaf is directly bonded to the insulation. FOAMGLAS® insulation is the robust and versatile material that has the required properties for this type of building solution.

## Air tightness of insulation and system

Air tightness of the system is achieved by the closed cellular glass structure of FOAMGLAS® and the adhesively bonded insulation layer itself with sealed joints. The installation method minimizes any risks from interstitial condensation. Heat losses due to the effects of air flow on insulants with low resistance to the passage of air, will not take place with the FOAMGLAS® system.

Use of FOAMGLAS® insulation allows for a totally integrated surface without the need to cut lengths around anchors and to stuff openings against air leaks.

FOAMGLAS® has best dimensional stability. It will not warp or sag and cannot create any blockage of the rear ventilation space. It remains stable under all conditions of use and temperature fluctuations and moisture will have no adverse effects. Butt-pressed and adhesive sealed joints ensure the structural stability of the system in the long-term; there will be no danger of air leaks and additional heat losses to develop in the course of time.

- 1 Waterproof** FOAMGLAS® is waterproof because it consists of pure glass. **Advantage:** does not absorb any moisture and does not swell.
- 2 Pest-proof** FOAMGLAS® cannot rot and is pest-proof because it is inorganic. **Advantage:** insulation without risk, especially in the base area and the soil. No basis for nesting, breeding or seed germination.
- 3 Compression-proof** FOAMGLAS® is extraordinarily in-compressible even with long-term loads due to its cell geometry without deformation. **Advantage:** use as load-bearing thermal insulation without risk.
- 4 Incombustible** FOAMGLAS® cannot burn because it consists of pure glass. Fire behaviour: Classification according to EN 13501: A1. **Advantage:** storage and processing not hazardous. No propagation of flames in the event of fire (chimney effect) in ventilation space.
- 5 Vapour-tight** FOAMGLAS® is vapour-tight because it consists of hermetically sealed glass cells. **Advantage:** cannot soak through and already contains the vapour barrier. Constant thermal insulation value over decades. Prevents the penetration of radon.
- 6 Dimensionally stable** FOAMGLAS® is dimensionally stable because glass neither shrinks nor swells. **Advantage:** no dishing, contracting or creep. Low coefficient of expansion, nearly equal to that of steel and concrete.
- 7 Acid-resistant** FOAMGLAS® is resistant to organic solvents and acids because it consists of pure glass. **Advantage:** no destruction of the insulation by aggressive mediums and atmospheres.
- 8 Easy to work with** FOAMGLAS® is easy to work with because it consists of thin-walled glass cells. **Advantage:** with simple tools like a saw blade or hand saw, FOAMGLAS® can be cut to any desired measurement.
- 9 Ecological** FOAMGLAS® is free of environmentally damaging flame retardants and propellants, no relevant eco-toxic components. **Advantage:** After generations of use as thermal insulation, FOAMGLAS® can be used again: as filler in landscaping or thermally insulating granulate. Ecologically sensible recycling through re-use.

## Heat losses as % due to cold bridging and air leaks

Source: EMPA, Schlussbericht F+E Nr. 127378 [Final report F+E Nr. 127378]

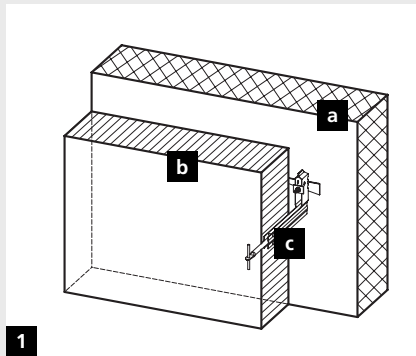

1

### 1 Anchoring system: Suspension and fixing systems

- a Load bearing wall
- b Thermal insulation
- c Single structural fastener

The quality of the workmanship on site can influence the heat losses by up to **30 %** (due to air leaks through the notches around fasteners in fibre wool insulation)



2

### 2 Ideally the structural fastener is perfectly encased

**+34%**



3

### 3 In practice the encasement of structural fasteners is less perfect

**+50%**

Bad workmanship and unsuitability of materials can have a dramatic effect on the thermal insulation values, particularly with cladding systems. In how far faulty workmanship on insulation has influence on the percentage of heat loss caused by cold bridging, has been shown by EMPA studies on ventilated façades (see pictures below). Additional heat loss caused by cold bridging can vary considerably in function of the quality level of workmanship. In case of air circulation around the insulation board, the heat loss from thermal transmittance can bump up to a considerable degree.

## FOAMGLAS® ensures that all physical and thermal demands are fulfilled

- FOAMGLAS® provides groundbreaking system solutions that significantly reduce the likelihood of cold bridging.
- The FOAMGLAS®-team draw first prize for the new façade insulation system FOAMGLAS®-plus, following a call for proposal by Swiss Federal Agency for Energy.
- FOAMGLAS®-plus: By use of metal fixing plates/claw plates applied to the insulation surface, the fixing devices for the subconstruction and cladding elements are positioned in front of the insulation layer, thus greatly reducing cold bridging.
- Another construction variant allows facing elements/bricks to be directly bonded to the FOAMGLAS® surface. This solution provides a totally cold bridge-free façade structure. FOAMGLAS® has the product qualities to fulfil the specific requirements of this system.
- FOAMGLAS® cellular glass insulation is totally air tight and the adhesively bonded slabs with closed joints ensure as well for structural integrity and optimal air tightness of the system.
- High density and dimensional stability of FOAMGLAS® add to the structural stability of the whole cladding concept and ensure that the insulation will not warp or sag when the building work is complete.



**1** The spread of fire across the façade and the roof can contribute to devastating total loss.

## Fire protection

After fire disasters heated discussions are aroused regarding responsibilities and fire precautions. Closer examination puts the question if the fire and the development of dangerous fumes could or should not have been prevented? The part played by insulation materials is a frequent issue. Studies provide clear evidence: FOAMGLAS® contributes to efficient passive fire protection. Cellular glass is non-combustible and does not give off fumes or toxic gases.

– because of the scale of the fire and the degrees of heat. The unfortunate coincidence of different factors can be the cause, as for instance a high fire load on the inside of the building, rapid spread of fire effluents, high wind and difficult access to the seat of fire. Reports of fire and rescue services can speak volumes ...

All the more care and attention has to be given to passive fire protection. By choosing adequate construction materials the risks of fire development – in particular the spread of fire across voids and flammable materials – can be reduced significantly.

### Preventive action starts with the choice of materials

“Fire disaster ... fire safety provisions violated ... two victims are still fighting for their lives ... there is evidence that fire safety regulations have been ignored ... rapid propagation of the fire has been encouraged ... sea of flames.”

These headlines make evident: To extinguish a fire in a building is sometimes rather difficult – even if building regulations on fire safety have been observed

### Smouldering fires – extraneous perils

Fires of this nature generally spread inside construction elements where they may go undetected for a long time. Sometimes hours may pass by between ignition and detection of the fire.

The specific structural and chemical characteristics of some insulants increase the risk of smouldering fires. This is not the case with FOAMGLAS®. The all glass closed cell structure of the insulation forms a shield.

## FOAMGLAS®: Neither fumes nor toxic gases

Fire disasters must not always be identical with “a sea of flames”. Have a flashback to the events on Düsseldorf Airport (1996) with 17 casualties and the fire in the Montblanc Highway Tunnel (1999), which caused the death of 39 people. In both cases toxic effluents from insulants, that were not fire safe, were considered responsible for the fatality (polystyrene in Düsseldorf, polyurethane at the Montblanc rock).

By contrast FOAMGLAS®, it does not give off fumes or toxic effluents. In respect of fire safety FOAMGLAS® is classified A1, non-combustible. The material with its all glass closed cell structure does not contain any binders.

Regarding fire safety FOAMGLAS® performs unlike all other insulants, classified as “non-combustible”. The big difference is that FOAMGLAS® does not glow or smoulder and does not cause the spread of fire across the construction.

## FOAMGLAS® melting point > 1000 °C

According to German DIN 4102-17 the melting point of FOAMGLAS® was tested at MPA Braunschweig Institute (D). More than 50% of the insulation thickness lasted the 90 minute fire period without significant damage. As an official result the melting point is >1000 °C.

## General protection with FOAMGLAS® in case of fire: Melt Shield-Effect

Comparable as a thermal protection shield the melted glass surface of the flame treated area is protecting the lower cell structure. The temperature on bearing structure is remaining low. FOAMGLAS® is defending the building structure in case of fire.

## To play safe: FOAMGLAS® for insulation

Recent fire testing yielded that cellular glass has excellent fire control attributes. Relevant test certificates are available from the national FOAMGLAS® subsidiaries. With regard to recent findings in preventive fire protection, architects and clients should redefine their safety requirements, which should be geared towards low-risk management for the façade structure under fire conditions.

If it is about quality standards in building, it makes sense to consider as well appropriate fire safety measures. Fire inquests are supposed to demonstrate the need to builders that the demands on fire safety should clearly be defined at an early stage in cross-functional cooperation of planning offices/architects, contractors and the client himself.

- 1 Fire in an apartment house, Lucerne, Switzerland.
- 2 Fire and toxic effluents: On Düsseldorf Airport a fire caused 17 casualties.
- 3 Conclusion after test procedure: FOAMGLAS® melting point > 1000 °C.



## FOAMGLAS® provides superior performance regarding preventive fire protection

- FOAMGLAS® is a safer product as it is pure and non-combustible cellular glass insulation. Reaction to fire classification: EN standard, Euro Class A1, Technical Agreement by VFK Nr. 5273).
- FOAMGLAS® thermal insulation performance is unaltered when exposed to extreme temperatures. The material does not soften up to 430° C and does not sag.
- Closed cell FOAMGLAS® insulation prevents oxygen to pass through the material to tease the trouble spot.
- FOAMGLAS® is gas-tight. The passage of hot gases through the insulation and their development inside the insulant is to be excluded. FOAMGLAS® is a safety insulation that forms a barrier against the propagation of the fire.
- Vapour-proof FOAMGLAS® does not need any additional protective layer, type vapour control layer. This means that the fire load is insignificant when compared with other insulants.
- FOAMGLAS® does not develop any flammable combustion residues, fumes or toxic effluents which can be harmful to health.

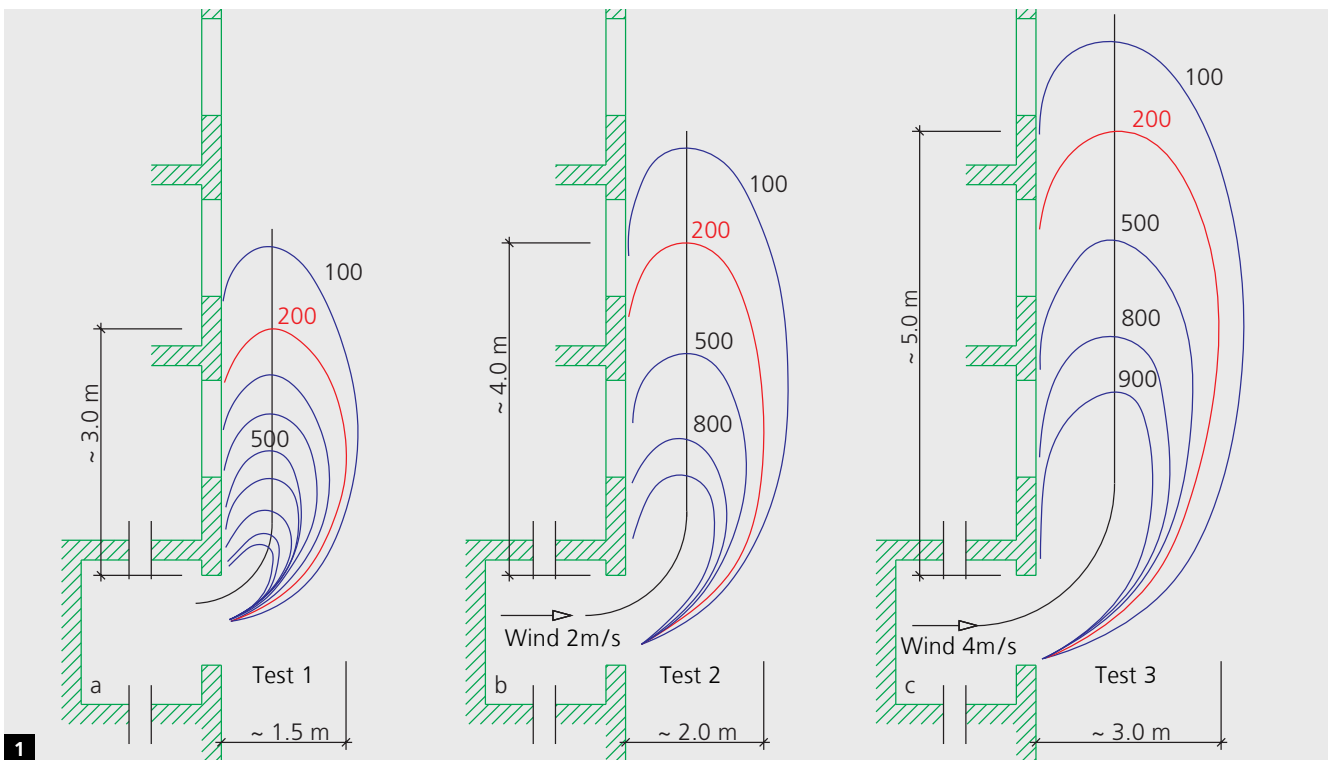

1 The figure shows the existing temperatures on a façade for three fire test set-ups under large-scale fire conditions.





- 1 The long-term performance of the insulation is decisive for financial efficiency in building.

## Durability is the key to economy

Successful property developers and house-builders plan ahead while taking investment decisions. Not the first low-priced solution that comes along is given the preference, but cost-efficiency in the long-term which yields a good return of investment pays out to be most profitable. This means that the protection of the fabric of the building, quality materials for the enclosure walls and a greater versatility in use for the interior surfaces are the main demands. With regard to energy efficiency the insulation material should provide a performance that remains totally effective for the lifetime of the building. FOAMGLAS® is able to fulfil these demands and moreover achieves the best useable floor ratio. The design structure of the insulated walls can be slimmer than for other insulation materials, which creates more useable space within the building structure.

### Secret qualities

Be it residential, commercial, industrial or public constructions: the quality of the insulation system for the roof and the façade is decisive for the service life of the building's structure. As with the flat roof it can be shown for the façade that long-term efficient constructions are more economical than cheap solutions. The façade of a build-

ing fulfils an important function: it needs to protect the fabric of the building from the effects of weather – cold, heat and rain. A wide range of aesthetic cladding materials in a great number of colours and shapes, including concrete, bricks, ceramics, natural stone, metal, fibre cement and many others, can be used. Usually they can protect a building for a period between 10 to 50 years or even longer. Often it is not the cladding that is the weakest link in the chain, but the thermal insulation.

Due to the effects from moisture, temperature fluctuations, wind and environmental pollution, the service life of many an insulant is shorter than that of the cladding material. Loss of structural integrity – warping and sagging – of the insulation material, which is exposed to climatic changes, will affect its performance and compromise the structural stability of the whole cladding concept.

This is not the case with FOAMGLAS®: The all glass closed cell structure of the insulation remains stable under all conditions of use. With high compressive strength it is robust against all sorts of stresses. FOAMGLAS® remains totally effective for the lifetime of the building.

## Unaffected, constant thermal insulation value over decades

Moisture absorption, loss of structural integrity and the passage of air on façades are nightmare scenarios. Quality loss on badly affected insula-

tion material results in considerable heat losses. Extensive repair works will become necessary. In particular with regard to today's greater insulation thicknesses, heat losses will be a major cost factor.

Due to the specific FOAMGLAS® properties – i.e. the impermeability to moisture, the structural stability – and the bonded installation method which protects against air leaks, a totally integrated surface is created which ensures efficient protection against serious damage.

To conclude: FOAMGLAS® insulation function and value will remain constant for decades; its sustainable performance plays a key part when high standards are required.

## No ventilation space – gain in useable space within the building structure

As FOAMGLAS® is impervious to moisture, no rain will wet the insulation on the weather side and no vapour transport will affect it from the room side. This means significant advantages. In summer there is no need for a ventilation space to allow interstitial condensation to “escape”.

Use of FOAMGLAS®-plus façade substructures dispenses with the need for a ventilation space and greatly reduces heat loss from cold bridging. The FOAMGLAS® rainscreen cladding system allows to gain several centimetres on the façade structure. This gain in useable space, calculated for the number of floor levels in the building, totals in a substantial gain in space.

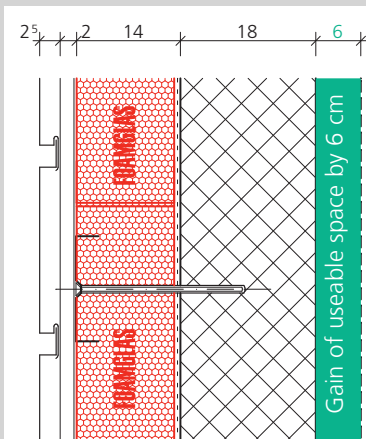

Façade structure based on FOAMGLAS®-plus substructure and FOAMGLAS® insulation slabs, type T4+, 140 mm thick, provides a U-value of 0.26 W/m<sup>2</sup>K

### Gain of useable space by 6 centimetre for a façade structure with an identical U-value, because:

1. Minimal heat losses due to the metal plate system
2. Minimal space required for the installation of the cladding (no ventilation space required)

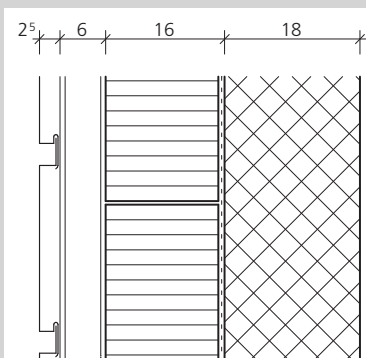

Conventional cladding system using wool insulation and aluminium steel support for the cladding, including a thermal buffer, provides a U-value of 0.26 W/m<sup>2</sup>K

## FOAMGLAS® – a new dimension in performance + economy

- Building with FOAMGLAS® is preferring a durable and cost-efficient solution instead of a low-end solution.
- FOAMGLAS® offers high structural stability (dimensionally stable) and is resistant to damage from demanding environmental conditions.
- Energy-efficiency in building requires an insulation material where insulation function and value will remain constant for the service life of the building. There is but one: FOAMGLAS®.
- Due to its outstanding physical qualities FOAMGLAS® perfectly resists to moisture, temperature fluctuations, passage of air, environmental pollution etc. and therefore obviates building refurbishment.
- FOAMGLAS® allows for exacting insulation values over decades, a most important item for buildings according to high energy standards like Swiss 'Minergie-' and 'Minergie-P-Standard'.
- The FOAMGLAS® system dispenses with the need for rear ventilation with rainscreen cladding – this gives the advantage of more useable space within the building structure.



## Excellent Ecological profile

FOAMGLAS® insulation systems are stable under all conditions of use and protects the owner from unexpected expenditures for heating or expensive replacement of the insulation or repair. FOAMGLAS® systems safeguard the environment one way or another. They allow for energy saving and, from the cradle to the grave, they do not contribute to environmental pollution, a safe product consistent with the principles of building physics. Cellular glass is certified to standards of health and indoor air quality. Ecologically viable product recycling is possible in the case of building demolition.

Typically 60%+ of the raw material is recycled glass. A very low percentage of carbon is added during manufacturing which makes the charcoal grey color of the insulation. In the cellulating furnace the soft, viscous glass is foamed through release of carbon dioxide (CO<sub>2</sub>) and forms millions of airtight glass cells enclosing the gas. This closed cell glass structure ensures full resistance to the transmission of vapor (resistance to water vapor transmission  $\mu = \infty$ ).

### Production and composition

FOAMGLAS® manufacturing is two sub-processes. In the first part of the process the recycled glass is melted and subsequently batched with the remaining raw materials and crushed in a mill. In the second sub-process the powder mix passes in the cellulating furnace at high temperature where FOAMGLAS® cellular glass is foamed – comparable to the process of fermentation in bread baking.

- 1 Renewable energy sources are increasingly used in FOAMGLAS® production.
- 2 FOAMGLAS®: millions of airtight glass cells



## Environmentally friendly production

The raw materials used in the FOAMGLAS® production are inherently mineral and thus environmentally friendly. Principal raw material is recycled glass. Further raw materials are feldspar, sodium carbonate, iron oxide, manganese oxide, carbon, sodium sulfate and sodium nitrate. By the introduction of recycled glass into the production FOAMGLAS® makes a relevant contribution to the protection of the environment.

## Minimal environmental pollution

Due to improvements in process engineering and in the energy supply (coming from hydro electric energy and wind turbines) significant progresses has been achieved in recent years regarding air pollution, greenhouse gas emissions, consumption of energy and resources:

- The demand for non-renewable energy was reduced 4.24 kWh/kg.
- Greenhouse gas emissions have been halved.
- The percentage of recycled glass was progressively increased from 0 % to 30 and to 60 %.
- The environmental pollution score (UBP97) was reduced from 1619 to 743 points.
- The eco-indicator (EI99 H, A) dropped from 0.13 to 0.09 points.

Reduction of the production energy means that the time period for energy amortization of the investment in thermal insulation – as an important evaluation unit – is considerably reduced.

## FOAMGLAS® manufacturing (Tessenderlo Plant, Belgium)

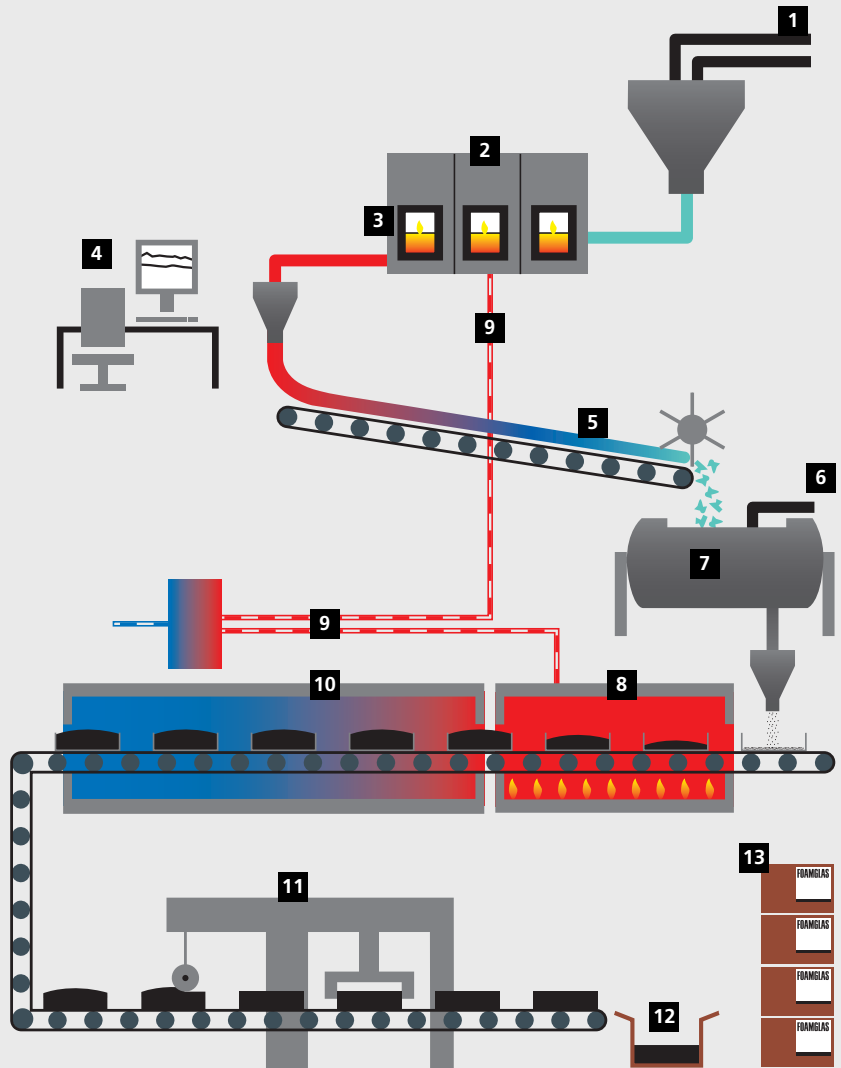

- 1 Mixing and batching of the raw materials: Recycled glass, feldspar, sodium carbonate, iron oxide, manganese oxide, sodium sulphate, sodium nitrate.
- 2 The melting furnace has a constant temperature of 1250°C.
- 3 Molten glass is drawn out of the furnace.
- 4 Control room for monitoring the production.
- 5 The glass is drawn off and falls onto the conveyor band where it cools down before entering into the ball mill.
- 6 Addition of "carbon black".
- 7 Ball mill grinds all ingredients into a fine powder before putting into stainless steel moulds.
- 8 The filled moulds pass through a cellulating oven (Foaming furnace) with a temperature of 850°C. This is where the material gains its unique cell structure.
- 9 Energy recovery of heat.
- 10 The FOAMGLAS® blocks pass through an annealing oven to allow carefully controlled cooling of them without thermal stress.
- 11 The blocks are cut to size and sorted by batch. Production waste is recycled.
- 12 FOAMGLAS® slabs are then packaged, labelled and palletized.
- 13 Finished FOAMGLAS® products are stored and prepared for transport.

### FOAMGLAS® stands comparison

The environmental pollution score (UBP 2006\*\*) for the production and waste disposal of FOAMGLAS® is 903 points/kg (insulation). This puts FOAMGLAS® into the pole position in eco-balance. Other insulation products show points between 2020 (stone wool) and 8490 (Extruded polystyrene).

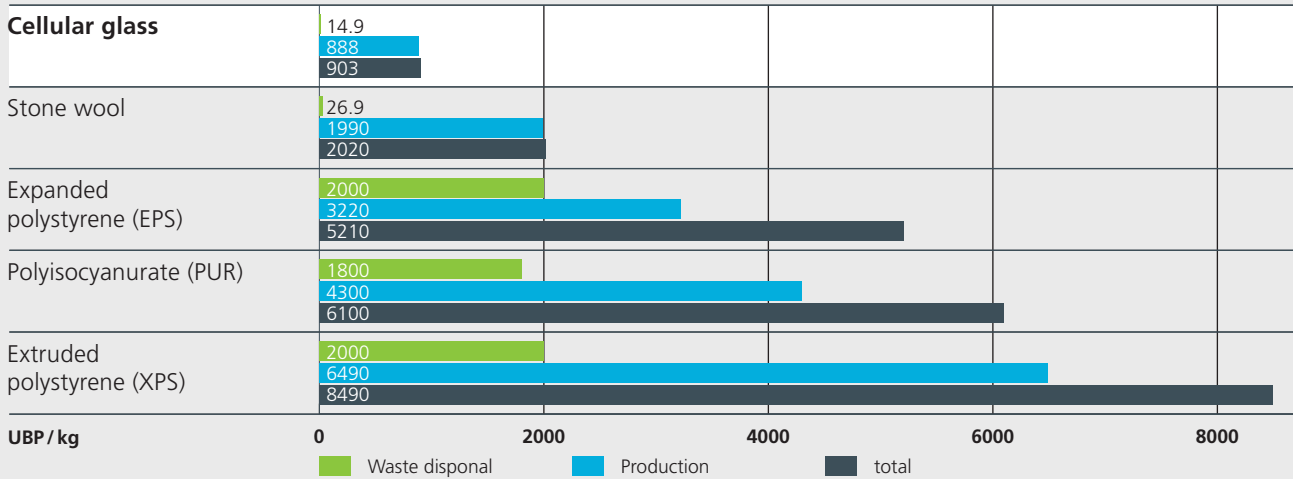

Compared to surfaces, with a specified insulation value of 0,20 W/m²K, FOAMGLAS® performs very well. The environmental pollution score (UBP 2006\*\*) of cellular glass is 17 157 points (FOAMGLAS® W+F), 21 807 points (FOAMGLAS® T4+) per square meter. Other insulation products show 23 790 points (PUR), 26 571 points (EPS), 46 056 points (stone wool) and 53 232 points (XPS) for an identical U-value (see table).

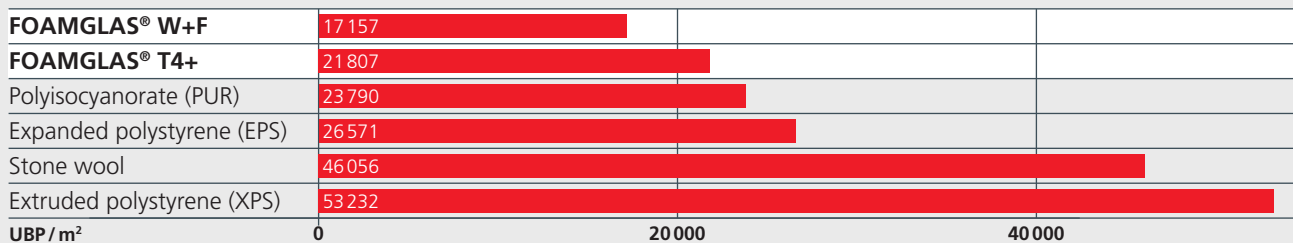

Insulation	ρ	λ <sub>D</sub> *	d	weight per m²	UBP* per kg	UBP per m²
	kg/m³	W/mK	m	kg/m²	UBP/kg	UBP/m²
<b>FOAMGLAS® T4+</b>	<b>115</b>	<b>0.041</b>	<b>0.21</b>	<b>24.15</b>	<b>903</b>	<b>~ 21 807</b>
<b>FOAMGLAS® W+F</b>	<b>100</b>	<b>0.038</b>	<b>0.19</b>	<b>19.00</b>	<b>903</b>	<b>~ 17 157</b>
Polyisocyanurate (PUR)	30	0.026	0.13	3.90	6100	~ 23 790
Stone wool	120	0.038	0.19	22.80	2020	~ 46 056
Expanded polystyrene (EPS)	30	0.034	0.17	5.10	5210	~ 26 571
Extruded polystyrene (XPS)	33	0.038	0.19	6.27	8490	~ 53 232

\* The data are taken from building database KBOB/EMPA, June 2009.

\*\* The environmental pollution score (UBP 2006) quantifies the pollution coming from resources, water consumption, emissions into air, water and ground and also for the waste disposal. The environment pollution through grey energy and global warming are included in the UBP score.

## World resources

The principal raw material of FOAMGLAS® production today is selected recycled glass (in the past the main raw material was silica sand). The supplies of recycled glass are ample, as in the construction and other industries large quantities amass and have to be disposed of as waste. Plastic foam insulation, however, is produced from crude oil, which is a non renewable fossil fuel.

## FOAMGLAS® cellular glass insulation products now with natureplus label

Natureplus, an international organisation for the development of a culture of sustainability within the building sector, has selected cellular glass thermal insulation from Pittsburgh Corning Europe SA as a green building product and awarded the natureplus quality label. "Cellular glass thermal insulation by Pittsburgh Corning Europe SA ideally meets the quality requirements for a sustainable construction product", noted Uwe Welteke-Fabricius, president of natureplus e.V., when handing-in the certificate. The natureplus quality seal is the symbol of recognition for building products with a high level of quality in the areas of health, the environment and functionality. Pittsburgh Corning's FOAMGLAS® types W+F, T4+, S3 and F from the Tessenderlo plant (Belgium) are tested and certified successfully.

## Service life

Having outstanding qualities (mineral, impermeable to water and vapor, resistant to acids, non-combustible, high-temperature resistant), cellular glass is a very durable material. The long service life of the material has very positive effects, ecologically and financially, on the service-life of the construction and, consequently, on the life of the building. Maintenance and replacement cycles can significantly be reduced by the use of durable materials.

## Emissions / nuisance during installation and use

Cellular glass does not release harmful or toxic components into the environment. It does not contain green house gases or ozone depleting products, no flame retardant and no con-taminative or carcinogenic particles and fibers. When recommended installation instructions are followed, cellular glass insulation does not produce emissions that degrade the environment or health, at production, installation nor use.

## Emissions in case of fire

Dumping and burning of construction waste is most critical for the environment, even in small quantities. In particular plastic foam materials are classified as harmful. In the case of burning of these materials high levels dangerous emissions are released than in combustion in an incineration plant. Studies have been conducted in Germany on

thermal combustion of polystyrene insulation, which clearly indicated that released fumes are acutely toxic. Serious adverse health effects in the long-term cannot be excluded. Even with combustion in a waste incineration plant, there is high impact to the environment, as annually several thousand tons of slag and filter residue have to be transported to special disposal sites. The non-combustibility of cellular glass makes the toxicity issues irrelevant.



natureplus – The European quality seal for approved green building products.

**Ecological assessment for different thermal Insulation materials.**

	Production energy	Resources	Nuisance for workers	Emissions during production	Emissions in case of fire	Long-term performance	Disposal / Recycling
Glass wool	Yellow	Yellow	Orange	Yellow	Yellow	Orange	Orange
Stone wool	Yellow	Yellow	Orange	Yellow	Yellow	Orange	Orange
Cellulose insulation	Yellow	Yellow	Yellow	Yellow	Yellow	Red	Yellow
Pure expanded cork	Yellow	Red	Yellow	Yellow	Yellow	Orange	Yellow
Expanded polystyrene	Orange	Red	Yellow	Yellow	Orange	Orange	Orange
Extruded polystyrene	Orange	Red	Orange	Yellow	Orange	Yellow	Red
Polyurethane (PUR)	Orange	Red	Orange	Yellow	Red	Orange	Red
FOAMGLAS®	Yellow	Yellow	Yellow	Yellow	Yellow	Yellow	Yellow

Very good      Acceptable      Critical      Very critical

Positive ecological assessment for FOAMGLAS®: Source: Cellular glass insulation, a cost-effective and environmentally sustainable solution. [Schaumglas-Dammstoff, Wirtschaftlich und umweltverträglich Dämmen.] Markus Welter, Lucerne

## Waste disposal

In the assessment of insulation materials one consideration is repercussions on the environment from waste disposal. There are significant differences between the various insulation products. In total evaluation – and considering the scarcity of raw materials – as documented in eco-balance data sheets for the building industry, plastic foam insulation receives poor ratings for environmental pollution.

## Recycling

Cellular glass being non-combustible, combustion in a waste incineration plant is not a possibility. An option is the recycling of cellular glass as crushed stone (for bedding in road construction) or infill material for noise barriers. Recycled FOAMGLAS® is a safe and suitable product for these applications, as it is dimensionally stable, neutral for the environment, inorganic, rot-proof and without any risks for the ground water (meets ELUAT-test requirements). If crushed and recycled FOAMGLAS® is not used as bedding or infill material, it can be taken to an inert waste disposal site, like crushed concrete or brick.

## FOAMGLAS® – a valuable contribution to the protection of the environment.

- Today FOAMGLAS® is made from 60 %+ recycled glass. The FOAMGLAS® manufacturing concept is waste reduction and green energy utilisation.
- For the FOAMGLAS® production only energy from renewable sources is used.
- Environmental pollution during manufacturing has halved when compared to 1995.
- FOAMGLAS® insulation meets all environmental and health requirements for construction products.
- At the end of its service-life FOAMGLAS® disposal is simple. One option is the use of recycled cellular glass as infill in trenches or back-up for buried pipes.
- FOAMGLAS® has an outstanding service-life, which is clearly the best for the environment.
- On balance: FOAMGLAS® is an insulation concept fit for the future that gives an answer to the genuine concerns for the environment. The system ensures that all demands on performance, durability, environmental integrity and sustainability are fulfilled.



- 3 The percentage of recycling glass in the FOAMGLAS® production is from 30 to 60 %.
- 4 Crushed FOAMGLAS® – a recycled filler material for trenches.
- 5 FOAMGLAS® Environmental product declaration (according to ISO 14025) confirms the sustainable and ecological value of FOAMGLAS®.

[www.foamglas.com](http://www.foamglas.com)



**Pittsburgh Corning Europe NV**

FOAMGLAS® Distributors  
Lasne Business Park, Building B  
Chaussée de Louvain 431, B-1380 Lasne  
Phone + 32 2 352 31 70  
info-intl@foamglas.com

**Pittsburgh Corning Europe NV  
Headquarters Europe, Middle East and Africa (EMEA)**

Albertkade 1, B-3980 Tessenderlo  
[www.foamglas.com](http://www.foamglas.com)

FOAMGLAS® Distributor

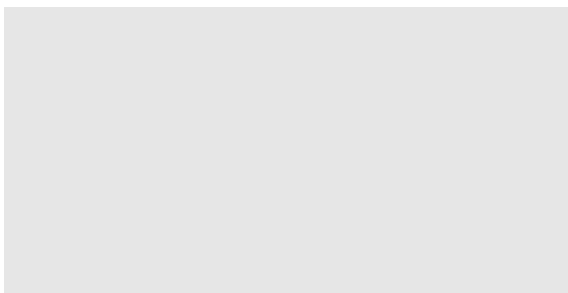

**ELUAT – elution test.** FOAMGLAS® meets the requirements of ELUAT test (Investigative report EMPA Nr. 123544 A, based on the successful testing of bitumen coated FOAMGLAS® specimens). According to declaration scheme D.093.09 of the Swiss Technical Directive for Waste Management [Technischen Verordnung über das Abfallwesen (TVA)], FOAMGLAS® is an authorised material for inert waste disposal sites.

**Copyright June 2012.** The product information and technical details contained in this brochure are accurate, according to our research and technical programme, at the point of going to press. We reserve the right to make any changes to the construction or product range, which seem technically appropriate, in view of our high standards for product advancement and development. All up-to-date data can be found under the button products on our website:  
[www.foamglas.com](http://www.foamglas.com)



Institut Bauen und Umwelt e.V.